

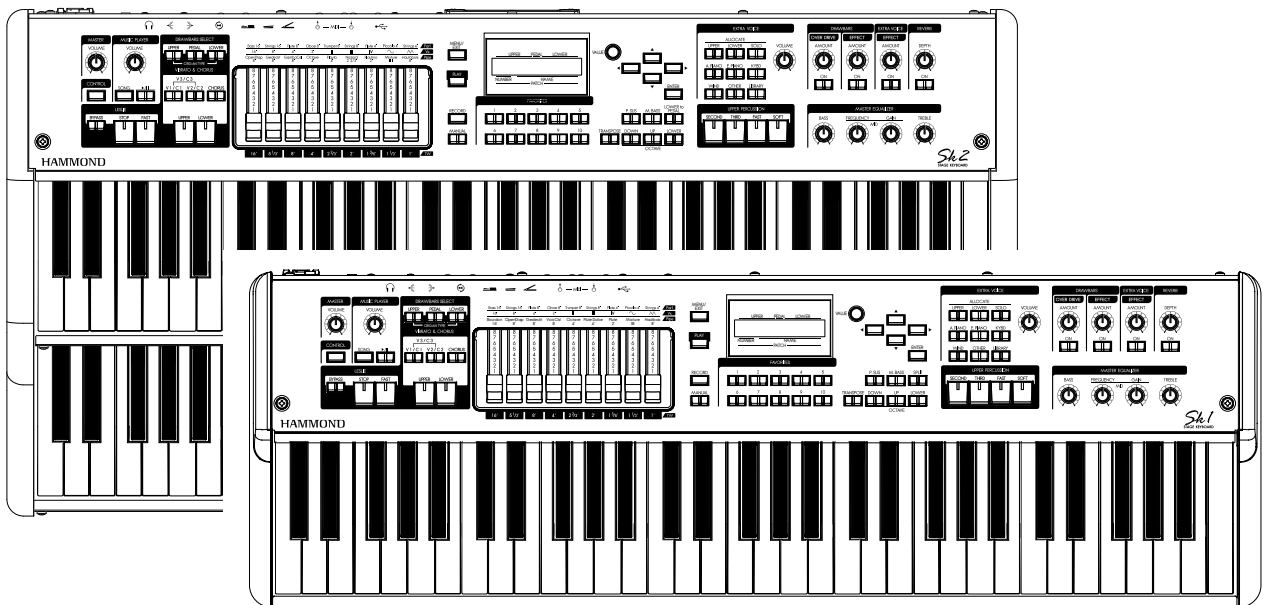

Model: *Sk1 / Sk2*
STAGE KEYBOARD

Thank you, and congratulations on your choice of the Hammond Stage Keyboard SK1/SK2.

The SK1 and SK2 are the first ever Stage Keyboards from Hammond to feature both traditional Hammond Organ Voices and the basic keyboard sounds every performer desires.



Please take the time to read this manual completely to take full advantage of the many features of your SK1/SK2; and please retain it for future reference.



Owner's Manual

IMPORTANT SAFETY INSTRUCTIONS

- ◆ Before using this unit, please read the following Safety instructions, and adhere to them.
- ◆ Keep this manual close by for easy reference.
- ◆ In this manual, the degrees of danger are classified and explained as follows:

	WARNING	This sign shows there is a risk of death or severe injury if this unit is not properly used as instructed.
	CAUTION	This sign shows there is a risk of injury or material damage if this unit is not properly used as instructed.

*Material damage here means a damage to the room, furniture or animals or pets.

WARNING



- ◆ Do not open (or modify in any way) the unit or its AC adaptor.



- ◆ Do not attempt to repair the unit, or replace parts in it. Refer all servicing to your retailer, the nearest Hammond Dealer, or an authorized Hammond distributor, as listed on the "Service" page.



- ◆ Never use or store the unit in places that are:
 - ◆ Subject to temperature extremes (e.g., direct sunlight in an enclosed vehicle, near a heating duct, on top of heat generating equipment)
 - ◆ Damp (e.g., baths, washrooms, on wet floors)
 - ◆ Humid
 - ◆ Exposed to rain
 - ◆ Dusty
 - ◆ Subject to high levels of vibration.



- ◆ Be sure to use only the AC adaptor supplied with the unit. And, make sure the line voltage at the installation matches the input voltage specified on the AC adaptor's case. Other AC adaptors may use a different polarity, or be designed for a different voltage, their use could result in damage, malfunction, or electric shock.



- ◆ Do not excessively twist or bend the power cord, or place heavy objects on it. Doing so can damage the cord, producing severed elements and short circuits. Damaged cords are fire and shock hazards!



- ◆ This unit, either alone or in combination with an amplifier and headphones or speakers, may be capable of producing sound levels that could cause permanent hearing loss. Do not operate for extended periods of time at a high volume level, or at a level that is uncomfortable. If you experience any hearing loss or ringing in the ears, you should immediately stop using the unit, and consult a physician.



- ◆ Do not allow any objects (e.g., flammable material, coins, pins); or liquids of any kind (water, soft drinks, etc.) to penetrate the unit.



- ◆ Immediately turn the power off, remove the AC adaptor from the outlet, and request servicing by your retailer, the nearest Hammond Dealer, or an authorized Hammond distributor, as listed on the "Service" page when:



- ◆ The AC adaptor, the power-supply cord, or the plug has been damaged; or
- ◆ If smoke or unusual odor occurs
- ◆ Objects have fallen into, or liquid has been spilled onto the unit; or
- ◆ The unit has been exposed to rain (or otherwise has become wet); or
- ◆ The unit does not appear to operate normally or exhibits a marked change in performance.



- ◆ In households with small children, an adult should provide supervision until the child is capable of following all the rules essential for the safe operation of the unit.



- ◆ Protect the unit from strong impact. (Do not drop it!)



- ◆ Do not force the unit's power-supply cord to share an outlet with an unreasonable number of other devices. Be especially careful when using extension cords - the total power used by all devices you have connected to the extension cord's outlet must never exceed the power rating (watts/amperes) for the extension cord. Excessive loads can cause the insulation on the cord to heat up and eventually melt through.



- ◆ Before using the unit in a foreign country, consult with your retailer, the nearest Hammond Dealer, or an authorized Hammond distributor, as listed on the "Service" page.



- ◆ Do not put anything that contains water (e.g., flower vases) on this unit. Also, avoid the use of insecticides, perfumes, alcohol, nail polish, spray cans, etc., near the unit. Swiftly wipe away any liquid that spills on the unit using a dry, soft cloth.



CAUTION



- ◆ The unit and the AC adaptor should be located so their location or position does not interfere with their proper ventilation.



- ◆ Never climb on top of, nor place heavy objects on the unit



- ◆ Always handle the AC adaptor by the plug when plugging into, or unplugging from an outlet or this unit.



- ◆ Never handle the AC adaptor or its plugs with wet hands when plugging into, or unplugging from, an outlet of this unit.



- ◆ At regular intervals, you should unplug the AC adaptor and clean it by using a dry cloth to wipe all dust and other accumulations away from its prongs. Also, disconnect the power plug from the power outlet whenever the unit is to remain unused for an extended period of time. Any accumulation of dust between the power plug and the power outlet can result in poor insulation and lead to fire.



- ◆ Before moving the unit, disconnect the AC adaptor and all cords coming from external devices.



- ◆ Before cleaning the unit, turn off the power and unplug the AC adaptor from the outlet.



- ◆ Try to prevent cords and cables from becoming entangled. Also, all cords and cables should be placed so they are out of the reach of children.



- ◆ Whenever you suspect the possibility of lightning in your area, disconnect the AC adaptor from the outlet.



In the unlikely event that you need to dispose of this unit, be sure to contact your dealer or your nearest town or municipal office for its proper disposal.

IMPORTANT - PLEASE READ

◆ **Power Supply**

- ◆ Do not use this unit on the same power circuit with any device that will generate line noise (such as an electric motor or variable lighting system).
- ◆ The AC adaptor will begin to generate heat after long hours of consecutive use. This is normal, and is not a cause for concern.
- ◆ Before connecting this unit to other devices, turn off the power to all units. This will help prevent malfunctions and/or damage to speakers or other devices.

◆ **Placement**

- ◆ Using the unit near power amplifiers (or other equipment containing large power transformers) may induce hum. To alleviate the problem, change the orientation of this unit; or move it farther away from the source of interference.
- ◆ This device may interfere with radio and television reception. Do not use this device in the vicinity of such receivers.
- ◆ Noise may be produced if wireless communications devices, such as cell phones, are operated in the vicinity of this unit. Such noise could occur when receiving or initiating a call, or while conversing. Should you experience such problems, you should relocate such wireless devices so they are at a greater distance from this unit, or switch them off.
- ◆ Do not expose the unit to direct sunlight, place it near devices that radiate heat, leave it inside an enclosed vehicle, or otherwise subject it to temperature extremes. Also, do not allow lighting devices that normally are used while their light source is very close to the unit (such as a piano light), or powerful spotlights to shine upon the same area of the unit for extended periods of time. Excessive heat can deform or discolor the unit.
- ◆ When moved from one location to another where the temperature and/or humidity is very different, water droplets (condensation) may form inside the unit. Damage or malfunction may result if you attempt to use the unit in this condition. Therefore, before using the unit, you must allow it to stand for several hours, until the condensation has completely evaporated.
- ◆ Do not allow rubber, vinyl, or similar materials to remain on the unit for long periods of time. Such objects can discolor or otherwise harmfully affect the finish.
- ◆ Do not paste stickers, decals, or the like to this instrument. Peeling such matter off the instrument may damage the exterior finish.

◆ **Maintenance**

- ◆ To clean the unit, use a dry, soft cloth; or one that is slightly dampened.
- ◆ To remove stubborn dirt off plastic parts, use a cloth impregnated with a mild, non-abrasive detergent. Afterwards, be sure to wipe the unit thoroughly with a soft, dry cloth. Try to wipe the entire surface using an equal amount of strength, moving the cloth along with the grain of the wood. Rubbing too hard in the same area can damage the finish.
- ◆ Never use benzine, thinners, alcohol or solvents of any

kind, to avoid the possibility of discoloration and/or deformation.

◆ **Additional Precautions**

- ◆ Please be aware that the contents of memory can be irretrievably lost as a result of a malfunction, or the improper operation of the unit. To protect yourself against the risk of losing important data, we recommend that you periodically save a backup copy of important data you have stored in the unit's memory in another MIDI device (e.g., a sequencer).
- ◆ Unfortunately, it may be impossible to restore the contents of data that was stored in another MIDI device (e.g., a sequencer) once it has been lost. Hammond assumes no liability concerning such loss of data.
- ◆ Use a reasonable amount of care when using the unit's buttons, sliders, or other controls; and when using its jacks and connectors. Rough handling can lead to malfunctions.
- ◆ When connecting / disconnecting all cables, grasp the connector itself - never pull on the cable. This will avoid causing short circuits, or damage to the cable's internal elements.
- ◆ To avoid disturbing your neighbors, try to keep the unit's volume at reasonable levels. You may prefer to use headphones, so you do not need to be concerned about those around you (especially when it is late at night).
- ◆ When you need to transport the unit, package it in the box (including padding) that it came in, if possible. Otherwise, you will need to use equivalent packaging materials.

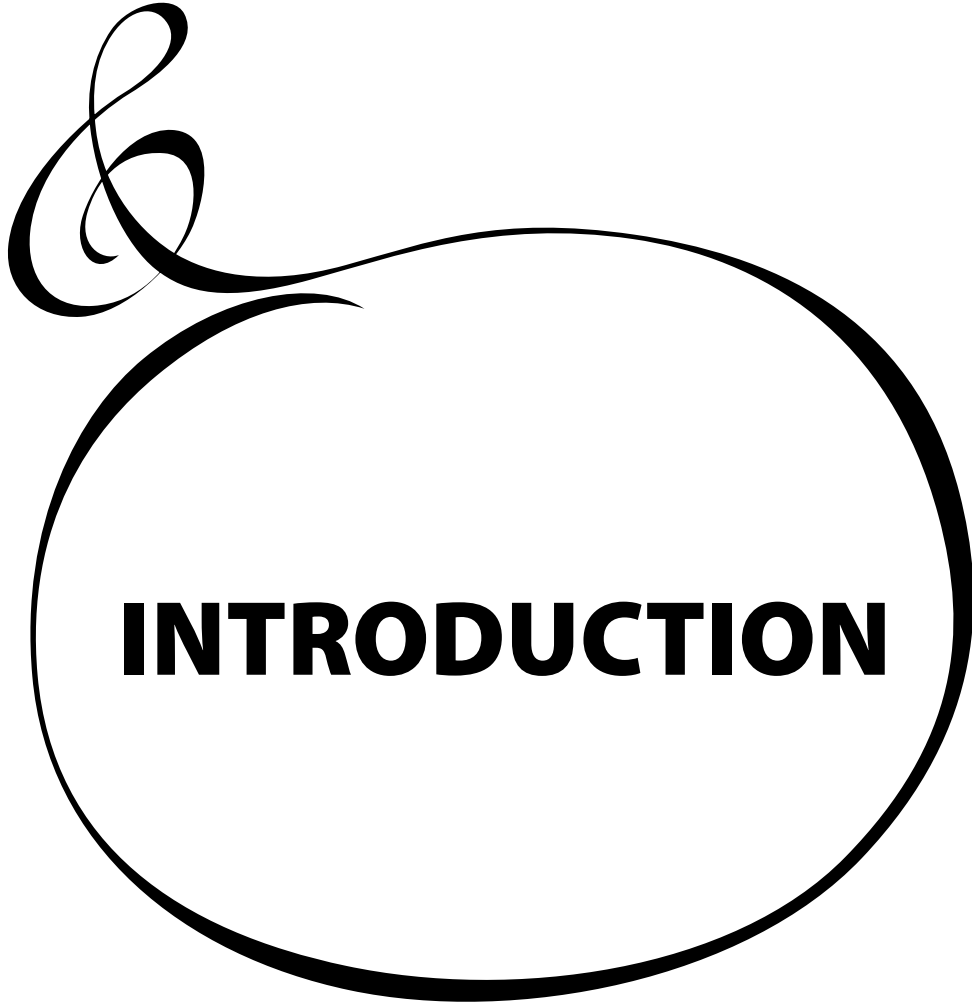
A decorative graphic featuring a treble clef on the left, with a thick black line extending from its base to form a large, rounded circle. The word "INTRODUCTION" is centered within this circle in a bold, black, sans-serif font.

INTRODUCTION

Table Of Contents

IMPORTANT SAFETY INSTRUCTIONS.....	2
IMPORTANT - PLEASE READ.....	4
INTRODUCTION	5
MAIN FEATURES	9
NAMES AND FUNCTIONS	10
TOP PANEL.....	10
REAR PANEL	13
KEYBOARD.....	14
ACCESSORIES.....	14
HOOK-UP	15
BASIC HOOK-UP	16
CONNECTING THE LESLIE SPEAKER	17
BASIC CONNECTION OF THE LESLIE SPEAKER.....	17
MIDI CONTROL OF THE LESLIE SPEAKER	17
EXPAND THE KEYBOARD.....	18
SK1: DUAL KEYBOARD + PEDALBOARD.....	18
SK1: ORGAN + PIANO.....	19
SK2: PEDALBOARD	20
GETTING READY TO PLAY	21
SWITCH ON	22
HOW TO POWER ON	22
BACK UP	22
RESET TO THE FACTORY SETTINGS	22
PLAY WITH THE PATCHES	23
USER and PRESET.....	23
HOW TO CALL A PATCH.....	23
Example: Select U041.....	23
REGISTER FAVORITE PATCHES (FAVORITES)	24
REGISTER PATCHES TO FAVORITES	24
HOW TO CALL FAVORITES	24
Column: RECORD FAVORITES LIKE PRESET BUTTONS.....	25
USE THE FOOT CONTROLLERS	26
EXPRESSION PEDAL	26
FOOT SWITCH.....	26
MASTER EQUALIZER	27
TRY CREATING YOUR OWN SOUND.....	28
SELECT [MANUAL]	28
Column: INITIALIZE THE INTERNAL SETTINGS [MANUAL].....	28
SELECT THE UPPER DRAWBARS.....	29
PULL OUT DRAWBARS.....	29
ADD THE TOUCH-RESPONSE PERCUSSION.....	29
ADD EFFECTS TO THE ORGAN SECTION	30
VIBRATO & CHORUS.....	30
LESLIE.....	30
OVERDRIVE	30
MULTI-EFFECTS	30
ALLOCATING THE EXTRA VOICES.....	31
SELECT AN INSTRUMENT	31
ADJUST THE VOLUME BALANCE.....	31
Column: To select the "A. Piano 2"	31

ADD EFFECTS TO THE EXTRA VOICE SECTION	32
MULTI-EFFECTS	32
ADD REVERB TO BOTH SECTIONS	32
REVERB	32
WHAT IS A "PART"?	33
KEYBOARD SPLIT	33
MANUAL BASS	33
LOWER TO PEDAL.....	34
PEDAL SUSTAIN	34
RECORD THE PATCH TO MEMORY	35
Example: RECORD TO U032	35
LOCKING THE DISPLAY	36

SETTING UP

37	
SOUND ENGINE STRUCTURE.....	38
ORGAN SECTION.....	39
EXTRA VOICE SECTION.....	39
MASTER EQUALIZER.....	39
ORGAN SECTION.....	40
ORGAN TYPE.....	40
TONE-WHEELS (BType1, BType2, Mellow)	40
TRANSISTOR (Vx, Farf)	40
PIPE.....	40
Column: SELECTING THE ORGAN TYPES.....	41
Example: Switching the manual part to "Pipe"	41
HARMONIC DRAWBARS™	42
DRAWBARS (ON TONE-WHEEL).....	42
DRAWBARS FOR THE UPPER AND LOWER PARTS	43
DRAWBARS TO USE ON THE PEDAL.....	43
DRAWBAR REGISTRATION PATTERNS.....	44
MODERN DRAWBAR REGISTRATIONS.....	45
DRAWBARS (Vx).....	46
DRAWBARS (Farf).....	47
DRAWBARS (PIPE)	48
DRAWBAR SELECT	49
ASSIGN DRAWBARS TO PARTS.....	49
MATCH THE REGISTRATION TO DRAWBARS.....	49
PERCUSSION.....	50
1' DRAWBAR CANCEL	50
VIBRATO & CHORUS.....	51
DRAWBAR OVERDRIVE.....	52
LESLIE.....	53
MULTI-EFFECTS, REVERB	54
PEDAL SUSTAIN, MANUAL BASS	55
KEYBOARD SPLIT, OCTAVE SHIFT	56
TRANPOSE	57
EXTRA VOICE SECTION	58
ALLOCATE AND SOLO.....	58
BUILT IN SOUNDS AND LIBRARY	58
MULTI-EFFECTS, REVERB	59
PATCH.....	60
USER AND PRESET	60
NAME THE PRESENT SETTING.....	61
RECORD TO THE PATCH.....	62

USING THE CONTROL PANEL..63

WHAT YOU CAN DO ON THE CONTROL PANEL.....	64
PLAY MODE.....	65
HOW TO READ THE DISPLAY	65
BUTTON OPERATION IN THIS MODE.....	65
MENU MODE	66
HOW TO READ THE DISPLAY	66
BUTTON OPERATION IN THIS MODE.....	66
MENU AND THE CONTENTS	67
FUNCTION MODE.....	68
HOW TO READ THE DISPLAY	68
BUTTON OPERATION IN THIS MODE.....	68
SHORT CUT TO FUNCTION MODE	69
EXAMPLE OF OPERATION:.....	69
REGISTER THE PAGES YOU FREQUENTLY USE.....	69
EXAMPLE OF OPERATION:.....	69
PARAMETER OPERATION EXAMPLE:.....	70

SETTING THE PARAMETERS ...73

DRAWBAR.....	74
◆SETTING FOR MANUAL (LOWER & UPPER) DRAWBARS	74
◆SETTING THE PEDAL PART.....	75
PATCH.....	76
◆PATCH NAME.....	76
◆PATCH LOAD	76
◆FAVORITES.....	76
EXVOICE (<u>Extra Voices</u>)	77
CONTROL.....	78
◆FOOT SWITCH.....	78
◆EXPRESSION.....	79
◆GLIDE.....	79
◆DAMPER	80
◆ASSIGN.....	80
◆DISPLAY.....	81
◆KEYBOARD	81
PERCUSS (<u>Percussion</u>)	82
VIB&CHO (<u>Vibrato & Chorus</u>)	83
LESLIE.....	84
◆CABINET NUMBER	84
◆LESLIE PARAMETERS.....	84
◆EXTERNAL LESLIE SPEAKER.....	86
RECORD THE CABINET.....	86
CUST. TW (<u>Custom Tone-Wheels</u>)	87
Record the CUSTOM virtual TONEWHEELS.....	89
PIPE.....	90
OD / EFF (<u>Overdrive / Effects</u>).....	92
◆ORGAN SECTION EFFECTS	92
OVERDRIVE	92
MULTI-EFFECTS	92
◆EFFECTS OF THE EXTRA VOICE SECTION	99
OVERDRIVE	99
MULTI-EFFECTS	99
EQUALIZ (<u>Equalizer</u>).....	100
◆ORGAN SECTION.....	100
◆ORGAN SECTION, EXTRA VOICE SECTION.....	100
◆MASTER EQUALIZER	100

REVERB	101
TUNE	102
◆MASTER TUNE	102
DEFAULT	103
SYSTEM.....	104

MIDI105

ABOUT MIDI.....	106
WHAT IS "MIDI"?	106
MIDI JACKS ON THIS KEYBOARD	106
WHAT THE MIDI CAN DO ON YOUR KEYBOARD.....	106
MAIN MIDI MESSAGE.....	107
CHANNEL MESSAGE.....	107
SYSTEM MESSAGE.....	107
MIDI STRUCTURE	108
◆KEYBOARD CHANNELS	108
◆EXTERNAL ZONE CHANNELS.....	108
◆EXPANDED KEYBOARDS.....	108
USING AN EXTERNAL SEQUENCER.....	110
◆Recording a performance to an external sequencer.....	110
◆Sequencer playback.....	110
USING A MIDI SOUND MODULE.....	111
ZONES.....	112
◆WHAT IS DISPLAYED ON THE UPPER LEFT?.....	112
◆INTERNAL ZONE.....	112
◆EXTERNAL ZONE	112
PANIC FUNCTION AND PARAMETER RE-LOAD.....	113
MIDI.....	114
◆MIDI TEMPLATE.....	114
◆MASTER.....	114
◆KEYBOARD CHANNELS	115

SAVE THE SETUP117

SAVE YOUR SETUP	118
WHAT YOU CAN DO WITH THE USB FLASH DRIVE.....	118
ABOUT USB FLASH DRIVE	118
USABLE USB FLASH DRIVE	118
USB MEMORY CONNECTOR.....	118
FOLDER STRUCTURE	118
INITIALIZE THE USB FLASH DRIVE	119
SETUP PROCEDURES	120
HOW TO READ THE DISPLAY	120
SAVE THE SETUP	120
CHANGE THE SETUP NAME	121
LOAD THE SETUP.....	122
DELETE THE SETUP	122
PATCH PROCEDURES	123
HOW TO READ THE DISPLAY	123
SAVE THE PATCH FILE.....	123
LOAD THE PATCH FILE	124
DELETE THE PATCH FILE.....	124

MUSIC PLAYER125

BEFORE PLAYING BACK	126
FILE TYPE AND PLACING FOLDER	126
HOW TO READ THE DISPLAY	126

OPERATION OF THE MUSIC PLAYER	127
MUSIC PLAYER MODES	128

VOICE LIBRARY 129

WHAT IS VOICE LIBRARY?	130
FILE TYPE AND THE PLACING FOLDER.....	130
VOICE LIBRARY AND SETUPS	130
OPERATE THE VOICE LIBRARY.....	131
LOADING THE VOICE LIBRARY	131
DELETE A LIBRARY	132
CLEAR ALL LIBRARIES	132

Troubleshooting 133

TROUBLESHOOTING.....	134
----------------------	-----

APPENDIX..... 135

EXTRA VOICE INSTRUMENT LIST	136
MIDI TEMPLATES.....	138
MIDI TEMPLATES OF SK1, SK1-73	138
MIDI TEMPLATES OF SK2	139
MIDI INFORMATION.....	140
MIDI Implementation.....	140
Channel Voice Message	140
Channel Mode Message	140
Drawbar Data List 1	141
Control Number.....	141
Drawbar Data List 2.....	141
System Exclusive Message.....	142
Mode Setting Exclusive Message	142
NRPN Switch	142
Data Set (Rx. only)	142
Identity Request (Rx. only)	142
Identity Reply (Tx. only)	142
Global Parameters	143
Patch Parameters	144
Leslie Parameters	148
System Parameters.....	148
Tonewheel Parameters	148
Pipe Parameters.....	148
CUSTOM TONE-WHEELS LIST	149
MIDI IMPLEMENTATION CHART.....	150
MIDI CHANNELS AND MESSAGES.....	151
SPECIFICATIONS.....	152
PRESET PATCH LIST.....	153
SERVICE.....	155

◆ **A LIBRARY OF ESSENTIAL KEYBOARD VOICES**

The modern keyboard player requires a wide palette of voices, including organs, pianos (acoustic and electric), wind and various keyboards.

◆ **AUTHENTIC HAMMOND DRAWBAR ORGAN**

The SK1/SK2 is first and foremost a genuine HAMMOND organ with Virtual Tone-Wheels to provide its traditional sound. Also available are the tones of vintage “combo” organs, and a variety of pipe organ ranks to provide church and classical organ voices.

◆ **EXTRA VOICE SECTION**

High Quality Acoustic and Electric Pianos are included, in multiple varieties of popular voices. Wind voices are also included. New voices will be able to be downloaded via the USB port.

The Organ and Extra Voice can be used together, and their outputs can be individually accessed, using the 8-pin Leslie speaker jack for the organ voice.

◆ **DIGITAL LESLIE/VIBRATO**

A digital and programmable LESLIE is available for the Drawbar voices, as well as the traditional “Chorus-Vibrato” as used on the legendary B-3. The Chorus-Vibrato may be selected for the Upper and Lower manuals, independently.

◆ **A WIDE VARIETY OF EFFECTS**

Digital Multi-effects are available for the Organ and Extra Voice sections independently. A Master Equalizer allows you to tailor the total tonal response of the keyboard.

◆ **MP3 MUSIC PLAYER**

This keyboard is equipped to play MP3 type audio files. This makes it very convenient for accompanying solo performances or practicing.

◆ **MIDI MASTER KEYBOARD**

External Zones are available to enable the SK1/SK2 to be used as a master keyboard.

◆ **PATCHS AND FAVORITES**

In addition to the 100 available user-defined patches, 10 “Favorite” quick-call patches are available for on-stage ease.

◆ **BUILT-IN USB PORT**

The versatile USB Flash Drive is adopted for easy access to a PC or for saving the audio file set up of the music player also for storing the voice library.

◆ **SMALL AND LIGHT WEIGHT**

Both the SK1 and SK2 are small and light weight, making transport and setup easy.

TOP PANEL

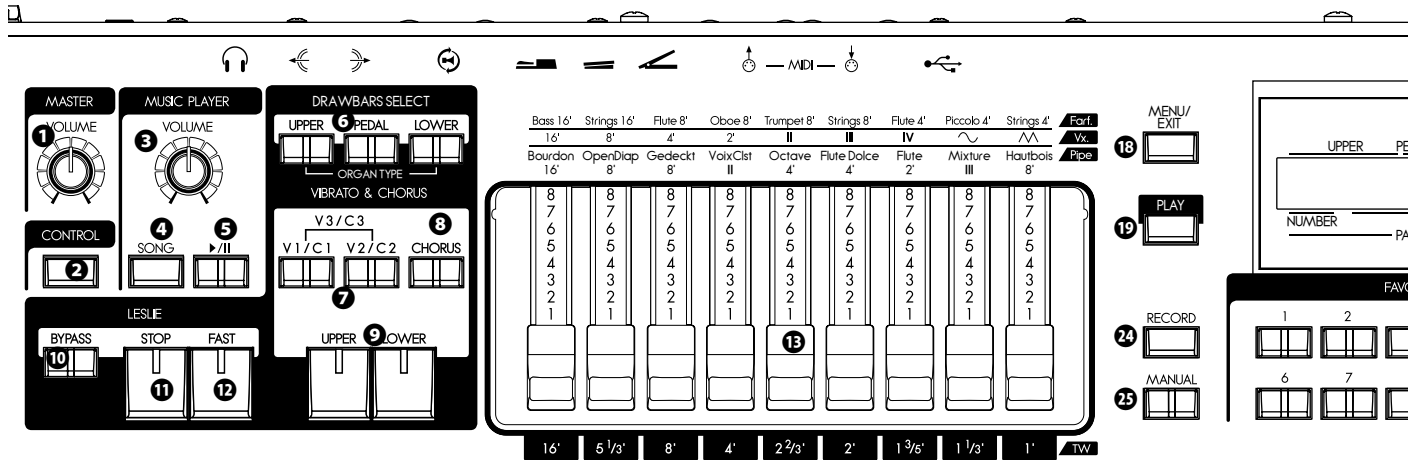

TOND

◆ UPPER LEFT

1 MASTER VOLUME knob

Controls the total volume. (P. 22)

2 CONTROL button

Brings the CONTROL window up in the display. (P. 78)

◆ MUSIC PLAYER

3 VOLUME knob

Controls the volume of the music player. (P. 127)

4 SONG button

Selects the audio file to play. (P. 127)

5 >/II button

Selects PLAY and PAUSE modes of the music player. (P. 127)

◆ DRAWBAR SELECT

6 UPPER, PEDAL, LOWER buttons

Used to select which division (Upper/Lower/Pedal) the Drawbar settings will affect while editing or playing live. The indicator light shows which selector is “live”. (P. 49)

◆ VIBRATO & CHORUS

7 V1/C1, V2/C2 buttons

Controls the depth of the classic “Vibrato & Chorus” effect. 1 is light, 2 is medium, and pressing both buttons selects 3 which is maximum. (P. 51)

8 CHORUS button

Toggles between Vibrato and Chorus effect. (P. 51)

9 UPPER, LOWER buttons

Selects which division (or both) receives the Vibrato & Chorus Effect. (P. 51)

◆ LESLIE

10 BYPASS button

De-selects the Leslie effect and directs the output to the Main outputs. When the indicator light is ON, the Bypass is engaged. (P. 53)

11 STOP button

Sets the STOP or SLOW then the [FAST] button is off. When the light is ON, the [FAST] button toggles STOP/FAST. And when the light is OFF, it toggles SLOW/FAST (P. 53)

12 FAST button

Toggles the modes of the rotors FAST or not. When the light is ON, it is FAST. (P. 53)

◆ DRAWBARS

13 DRAWBARS

These are for adjusting the basic harmonics of the organ section. The function of each drawbar is different depending on the keyboard selected (Upper/Lower/Pedal) of type of Organ (Transistor/Pipe). (P. 42)

◆ PERCUSSION

14 SECOND button

Adds 4' percussion (decay) to the UPPER part. (P. 50)

15 THIRD button

Adds 2 2/3' percussion (decay) to the UPPER part. (P. 50)

16 FAST button

Switches the decay time of the percussion. (P. 50)

17 SOFT button

Switches the percussion volume. (P. 50)

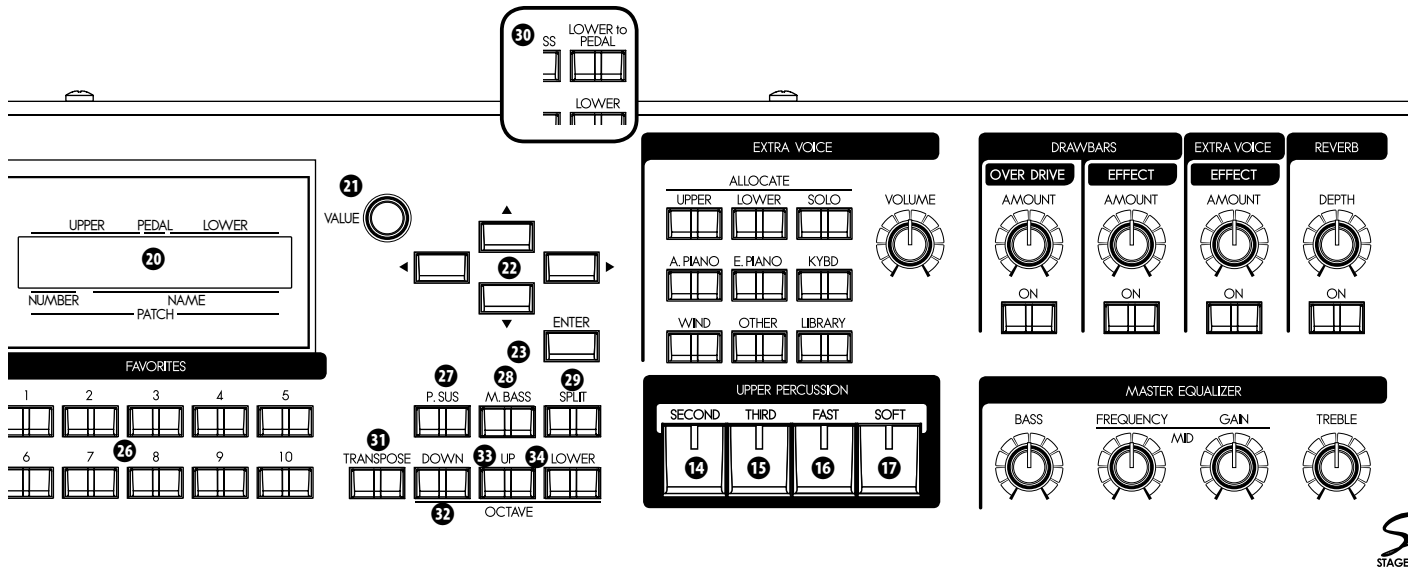

◆ CONTROL PANEL

18 MENU/EXIT button

Recalls the Menu mode in the display. Also used for returning to the Menu mode from other function modes. (P. 66)

19 PLAY button

Returns to the Play, or basic mode. (P. 65)

20 DISPLAY

21 VALUE knob

Increases/Decreases Patch numbers while performing or adjusts values during editing.

22 DIRECTION buttons

Moves the cursor or pages.

23 ENTER button

Confirms the current entry or procedure.

◆ FAVORITES

24 RECORD button

Enables recording of user-definable items. (P. 35)

25 MANUAL button

Dismisses any current Patch or Favorite in favor of the current settings of the control panel. (P. 28)

26 NUMBER buttons

Recalls the corresponding Favorites. (P. 24)

◆ KEYBOARD CONTROL

27 P. SUS (Pedal SUSTain) button

Switches the Pedal Sustain on. (P. 34)

28 M. BASS (Manual BASS) button

Switches the Manual Bass on. (P. 33)

29 SPLIT button (only on the SK1)

Divides the SK1 keyboard into UPPER and LOWER. (P. 33)

30 LOWER to PEDAL button (only on the SK2)

Couples the LOWER part to the pedalboard. (P. 34)

31 TRANSPOSE button

Shifts the entire instrument's key signature Up or Down. (P. 57)

32 OCTAVE DOWN button

Lowers the UPPER part by one octave. (P. 56)

33 OCTAVE UP button

Raises the UPPER part by one octave. (P. 56)

34 OCTAVE LOWER button

Raises and lowers the octave of the LOWER part, together with the OCTAVE DOWN/UP buttons. (P. 56)

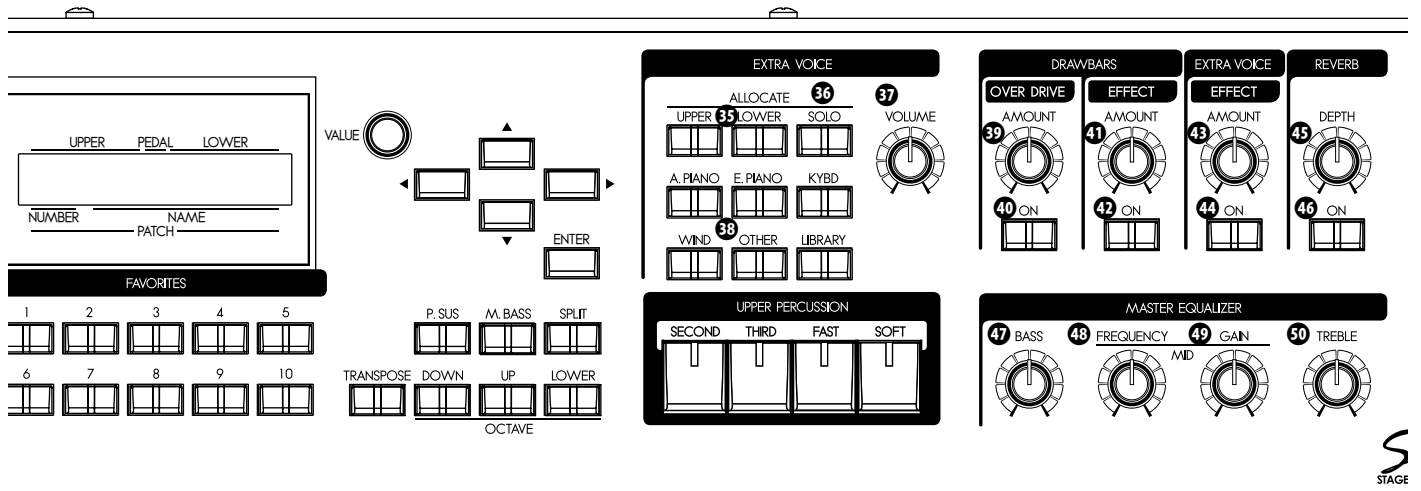

◆ **EXTRA VOICES**

35 ALLOCATE UPPER, LOWER button

Toggles the Extra Voices to the UPPER, and LOWER parts. The light illuminates when button is pressed (on). (P. 58)

36 SOLO button

Mutes the organ section and only the Extra Voices sound. (P. 58)

37 VOLUME knob

Adjusts the volume of the Extra Voices. (P. 31)

38 VOICE GROUP buttons

Selects the voice group of the Extra Voices. (P. 31)

◆ **ORGAN SECTION EFFECTS**

39 DRAWBARS OVERDRIVE AMOUNT knob

Adjusts the amount of the Overdrive effect. (P. 52)

40 DRAWBARS OVERDRIVE ON button

Switches the overdrive effect ON/OFF. (P. 52)

41 DRAWBARS EFFECT AMOUNT knob

Adjusts the amount of the Multi-Effects. (P. 54)

42 DRAWBARS EFFECT ON button

Switches the Multi-Effects ON/OFF. (P. 54)

◆ **EFFECTS OF THE EXTRA VOICE SECTION**

43 EXTRA VOICE EFFECT AMOUNT knob

Adjusts the depth of the Multi-Effects. (P. 59)

44 EXTRA VOICE EFFECT ON button

Switches the Multi-Effects ON/OFF. (P. 59)

◆ **EFFECTS FOR ALL PARTS**

45 REVERB DEPTH knob

Adjusts the depth of the Reverb. (P. 54)

46 REVERB ON button

Switches the Reverb ON/OFF. (P. 54)

◆ **MASTER EQUALIZER**

47 BASS knob

Adjusts the boost/cut the of bass frequencies. (P. 27)

48 MID FREQUENCY knob

Sets the frequency the MID GAIN knob will adjust. (P. 27)

49 MID GAIN knob

Adjusts the boost/cut of the mid range frequency as set by the MID Frequency knob. (P. 27)

50 TREBLE knob

Adjusts the boost/cut of the treble frequencies. (P. 27)

REAR PANEL

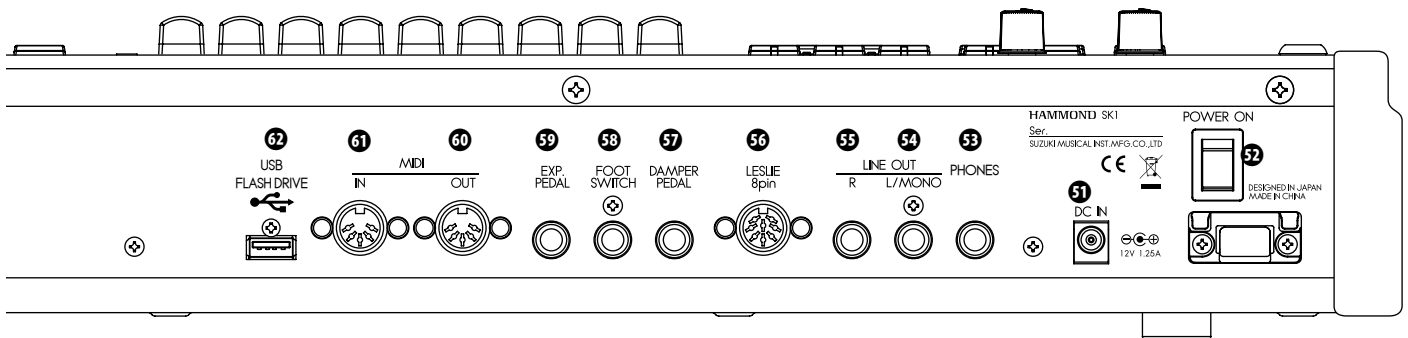

◆ POWER

51 DC IN jack

Connect the AC adaptor AD3-1250 to this jack.

52 POWER switch

◆ SOUND OUTPUT TERMINALS

53 PHONES jack

Connect stereo headphones here.

Connecting Headphones does NOT mute the Line or Leslie Outputs.

54 LINE OUT L/MONO jack

55 LINE OUT R jack

These are the sound output jacks.

If the connected mixer or monitor speaker is stereophonic, connect both L and R. If monaural, connect only to the L/MONO terminal (P. 16) and set the Audio Mode at “MONO” (P. 104).

56 LESLIE 8 PIN jack

Connect a Leslie Speaker equipped with an eight-pin jack here.

When the connection of a physical Leslie Speaker is detected, the on-board digital Leslie Simulator to the PHONES jack (53) and the LINE OUT jacks (54, 55) are disabled. (P. 17)

◆ CONTROLLER TERMINALS

57 DAMPER PEDAL jack

Connect an optional Damper Pedal (optional FS-9H etc.) here.

If you press the damper pedal, holding down the keyboard, the sound is sustained even after you release your finger from the key. (P. 78)

58 FOOT SWITCH jack

Connect the Foot Switch (optional FS-9H etc.) here.

Consult (P. 78) to learn the different functions available for the foot switch.

59 EXP. PEDAL jack

Connect the Expression Pedal (optional EXP-50 etc.) here.

Controls volume while you are playing. (P. 78)

◆ MIDI TERMINALS

60 MIDI OUT jack

MIDI information is output from this jack. (P. 106)

61 MIDI IN jack

MIDI received here. From the factory, this terminal is set to receive channels in accordance with using a lower manual and pedalboard. (P. 106)

◆ USB TERMINAL

52 USB FLASH DRIVE jack

This jack is for connecting a USB Flash drive. (P. 118)

KEYBOARD

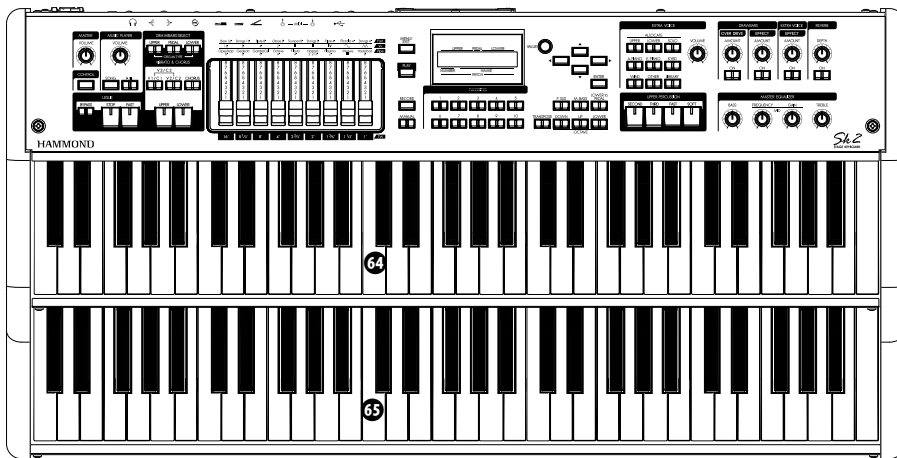
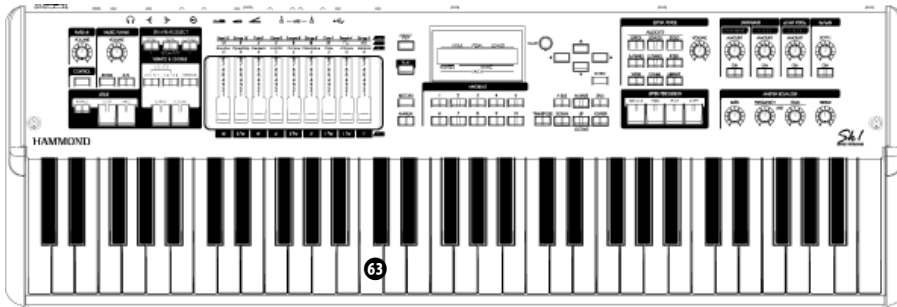

63 Keyboard (SK1)

61 (for SK1), 73 (SK1-73), semi-weighted 88 (SK1-88) waterfall keys, velocity sensitive.

64 UPPER keyboard (SK2)

This is for playing the UPPER part.

65 LOWER keyboard (SK2)

This is for playing the LOWER part.

ACCESSORIES

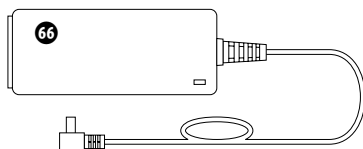

66 AC adaptor

Supplies power to the instrument - USE ONLY AD3-1250, DO NOT SUBSTITUTE!

67 AC cord set

Attaches AC adapter to Wall outlet.

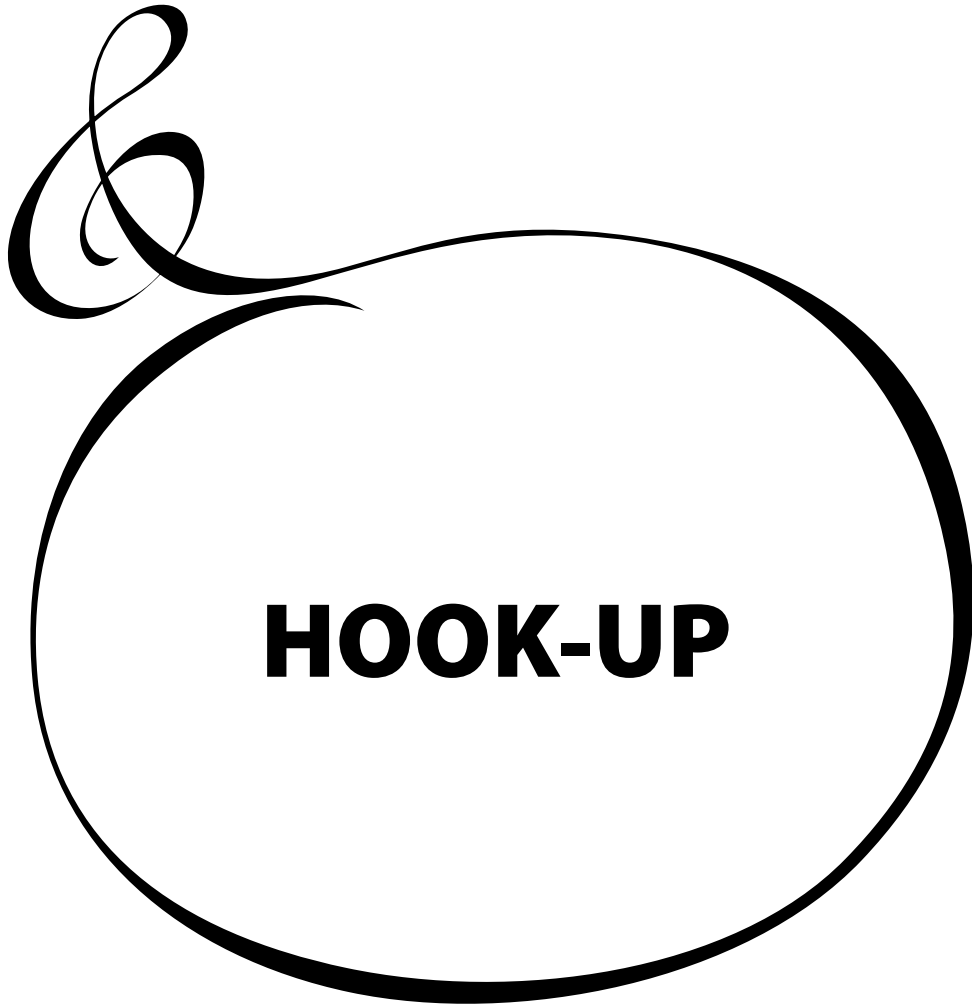

BASIC HOOK-UP

Attach cables and accessories as illustrated.

There is no on-board amplification or speaker system. An external amp/speaker is required. When the stereo headphones are connected to the PHONES jack, you can enjoy playing it or practising by yourself.

Switch this unit, and any external equipment OFF before connecting amps or headphones.

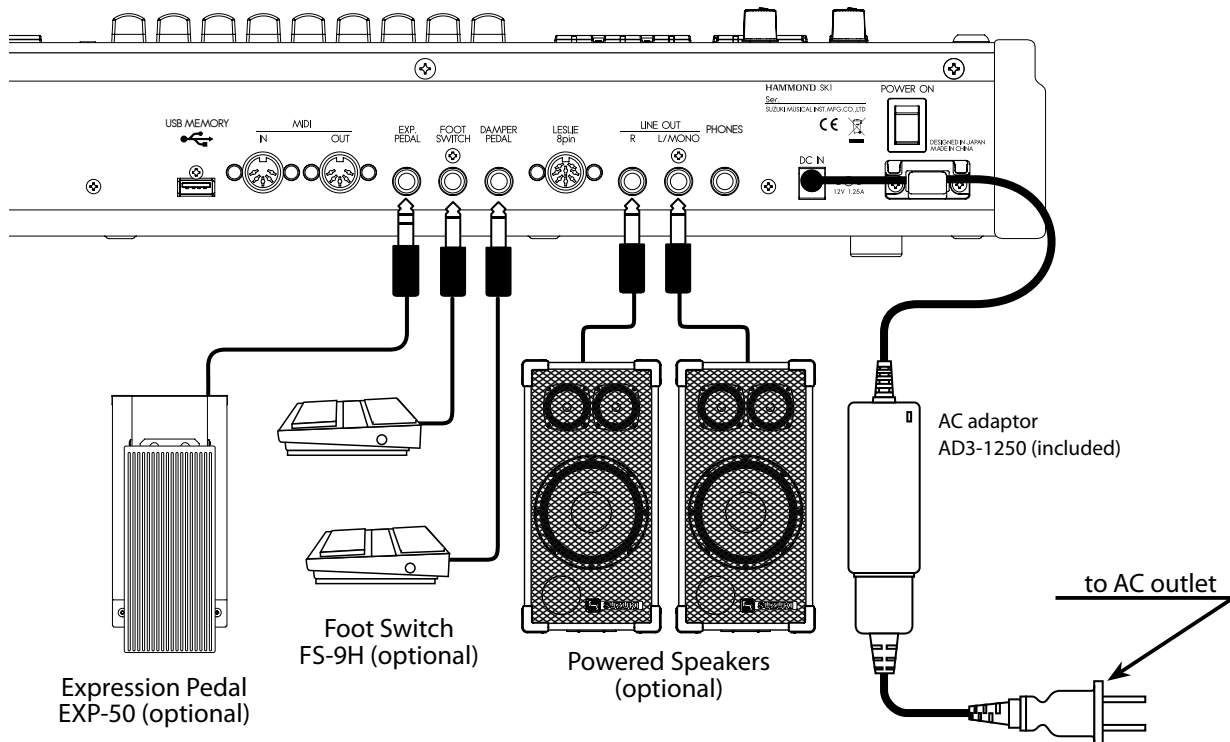

The Expression Pedal and Foot Switch parameters must be set properly. For details see [CONTROL] (P. 78)

Select Audio Mode for stereo or mono connection (P. 104)

⚠ CAUTION

Do not place this unit in direct sun light, near heat sources, or in a hot location.

An 8-pin type Leslie speaker can be directly connected to this keyboard.

❖ Switch keyboard OFF before connecting the Leslie speaker.

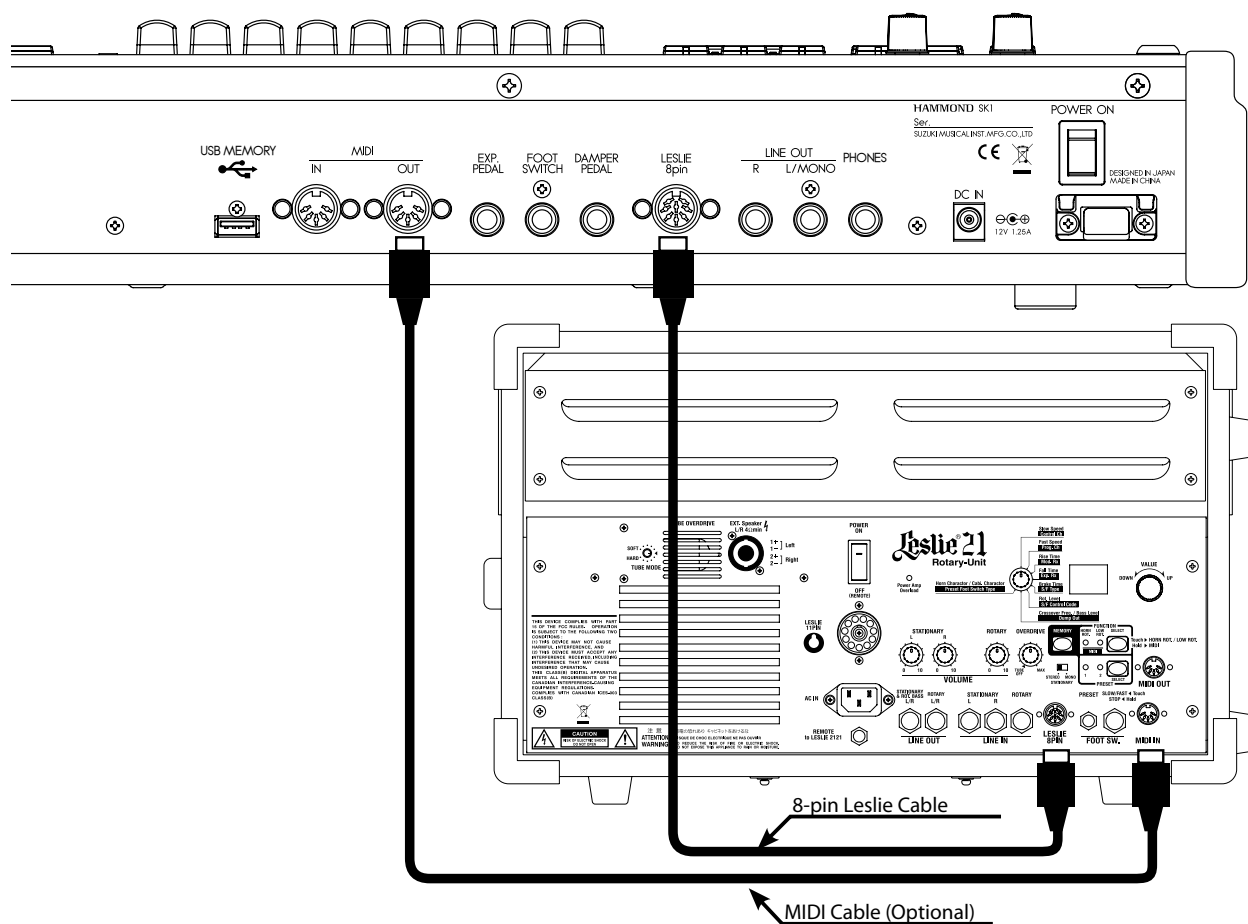

BASIC CONNECTION OF THE LESLIE SPEAKER

Connect the Leslie Speaker #2101, or #2101mk2 and the Leslie 8-PIN jack on this keyboard with the exclusive 8-pin Leslie cable (optional LC-8-7M, not included).

NOTE: The Leslie terminal on this unit is of 8-pin specifications. Use the Leslie adaptor XLD-811 (optional) to connect a 11-pin spec. Leslie speaker e.g. #122XB.

1. Make the setting of Tone-Wheel organ.
2. Switch "ON" the [BYPASS] button, set the [STATIONARY VOLUME] of the #2101/mk2 at desired volume.
3. Repeat "ON/OFF" the [BYPASS] button with playing the keyboard, set the [ROTARY VOLUME] of the #2101/mk2 at same volume which you can hear.

MIDI CONTROL OF THE LESLIE SPEAKER

To control the parameters of the Leslie Speaker #2101, #2101mk2 (fine adjustment of the rotor speed or the rise time, etc.):

1. Connect the MIDI OUT of this unit with the MIDI IN of the Leslie speaker with a MIDI cable.
2. Set the keyboard channel - UPPER and the Leslie MIDI channel to the same channel. (P. 115)

When this unit detects that the Leslie speaker is connected, the Leslie parameters sent through MIDI from this unit are switched from the SK original to those for the Leslie speaker.

tips LESLIE SPEAKERS TO BE CONNECTED

This keyboard is designed to connect with 3 channel Leslie speakers such as #2101. However, it is also possible to connect 1 channel type Leslie speakers such as #3300 sending the stationary channels to the LINE OUT jacks independently. (P. 86)

tips LESLIE CHANNEL

3 channel type Leslie speakers are equipped with a stereo speaker system, independent of the rotor, to provide stereo sound for the Extra Voices and direct organ sounds.

A traditional 1-channel Leslie, such as a #122 or #147 has no stationary speaker system, thus requiring a separate amplifier/speaker for the Extra Voices or direct organ sounds.

EXPAND THE KEYBOARD

This instrument can be upgraded to dual keyboards by connecting an external MIDI keyboard and pedalboard.

SK1: DUAL KEYBOARD + PEDALBOARD

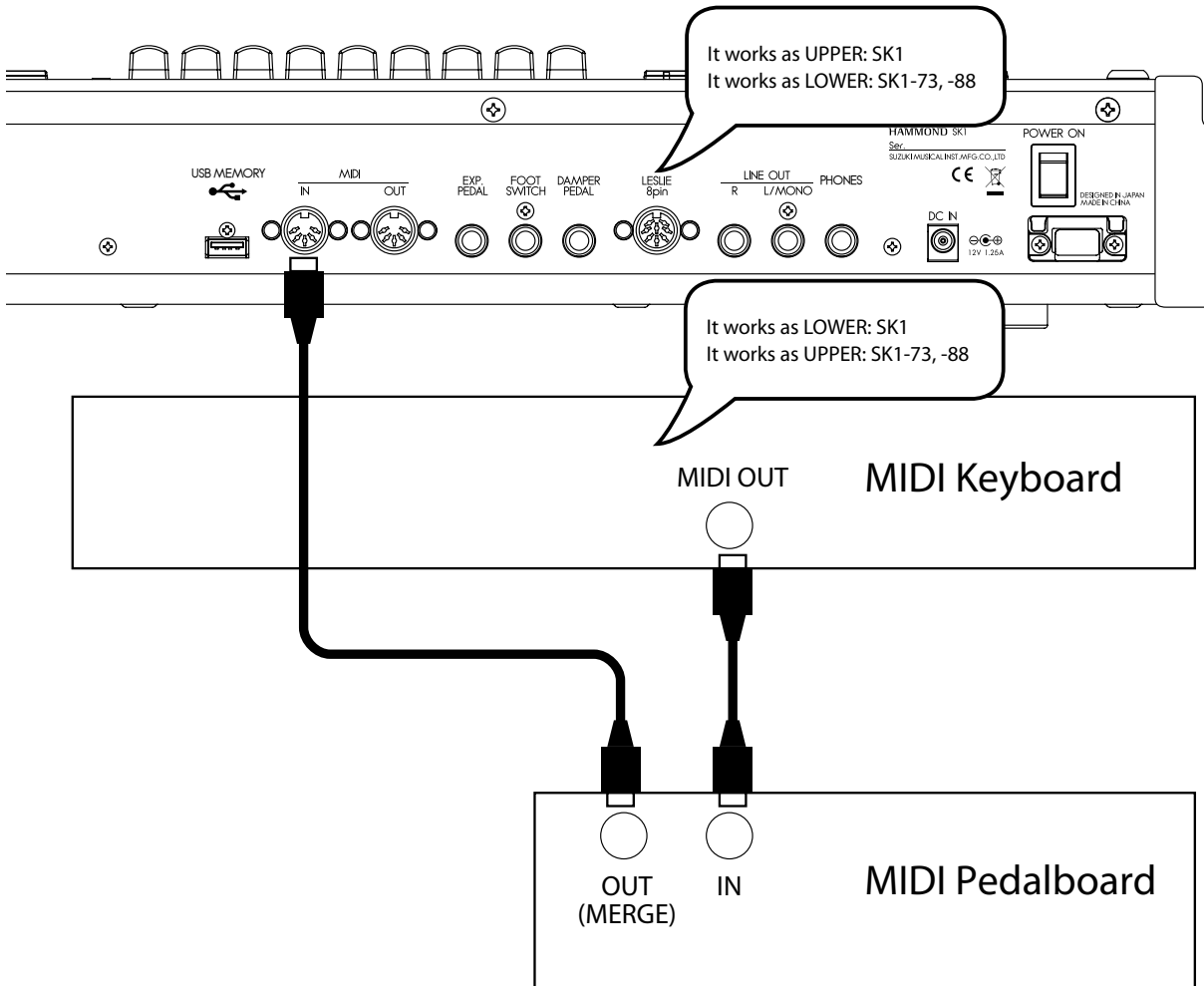

1. Connect as illustrated above. There is only one MIDI IN jack onboard this instrument, so a MIDI keyboard with a merge function or a MIDI Merge-box is necessary for realizing a dual keyboard configuration.

NOTE: This illustration shows only the keyboard expansion See P. 16 for the basic hook up of the power source, audio, etc.

2. Turn the SK1 power ON. Then recall the MIDI template "3KBD". (P. 114)
3. Set the Send channel of the added MIDI keyboard at "2" ("1" on SK1-73, -88) and that of the MIDI pedalboard at "3".

Refer to the operation manual of the added MIDI keyboard and pedalboard, as required.

◆ RECOMMENDABLE MIDI KEYBOARD

The following HAMMOND MIDI pedal keyboards (compliant with the SK1) are available from our sales dealers:

- ◆ MIDI pedalboard XPK-100 (13 keys)
- ◆ MIDI pedalboard XPK-200 (20 keys)

Both models have a MIDI merge function.

tips HOW MIDI KEYBOARD WORKS?

On the SK1, connected MIDI keyboard works as "LOWER" keyboard when the MIDI template recalled at "3KBD" or "Two Manual".

On the SK1-73 or -88, connected MIDI keyboard works as "UPPER" keyboard when the MIDI template recalled at "3KBD" or "Two Manual".

SK1: ORGAN + PIANO

You can create a comprehensive basic keyboard rig by utilizing a separate keyboard controller for the Extra Voices (Piano, Etc) and using the SK-1 keyboard for Organ.

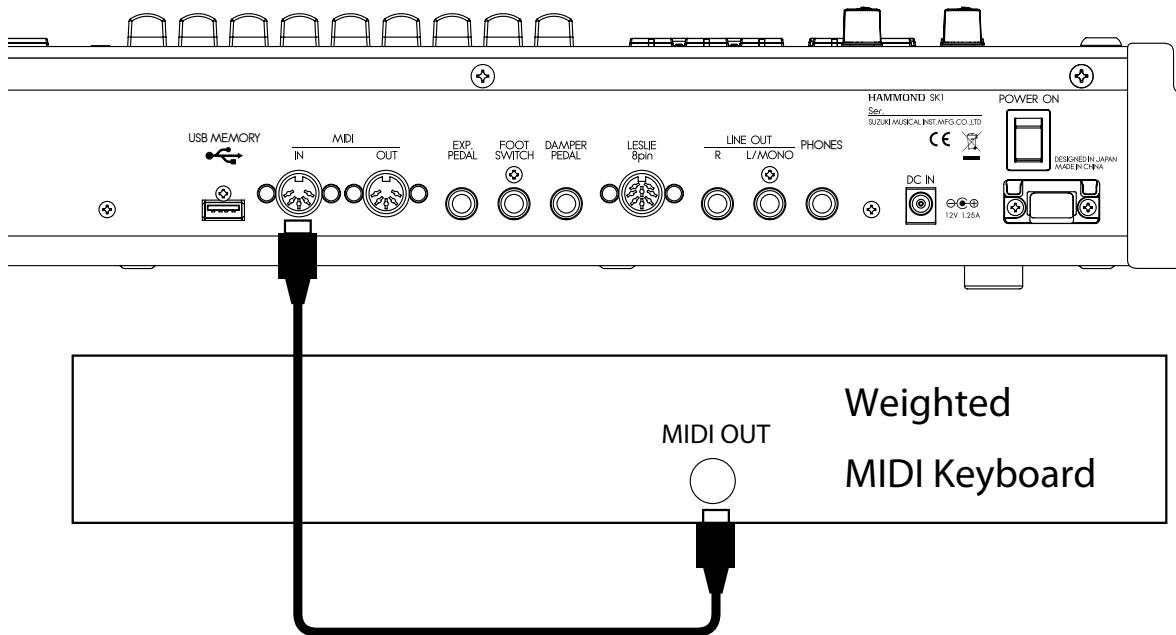

1. Connect as illustrated.

NOTE: This illustration shows only the keyboard expansion. See P. 16 for the basic hook up of the power source, audio, etc.

2. Switch ON the power of this unit. Then recall the MIDI template “Extra Voice”. (P. 114)

Refer to the operation manual of the added MIDI keyboard as required.

SK2: PEDALBOARD

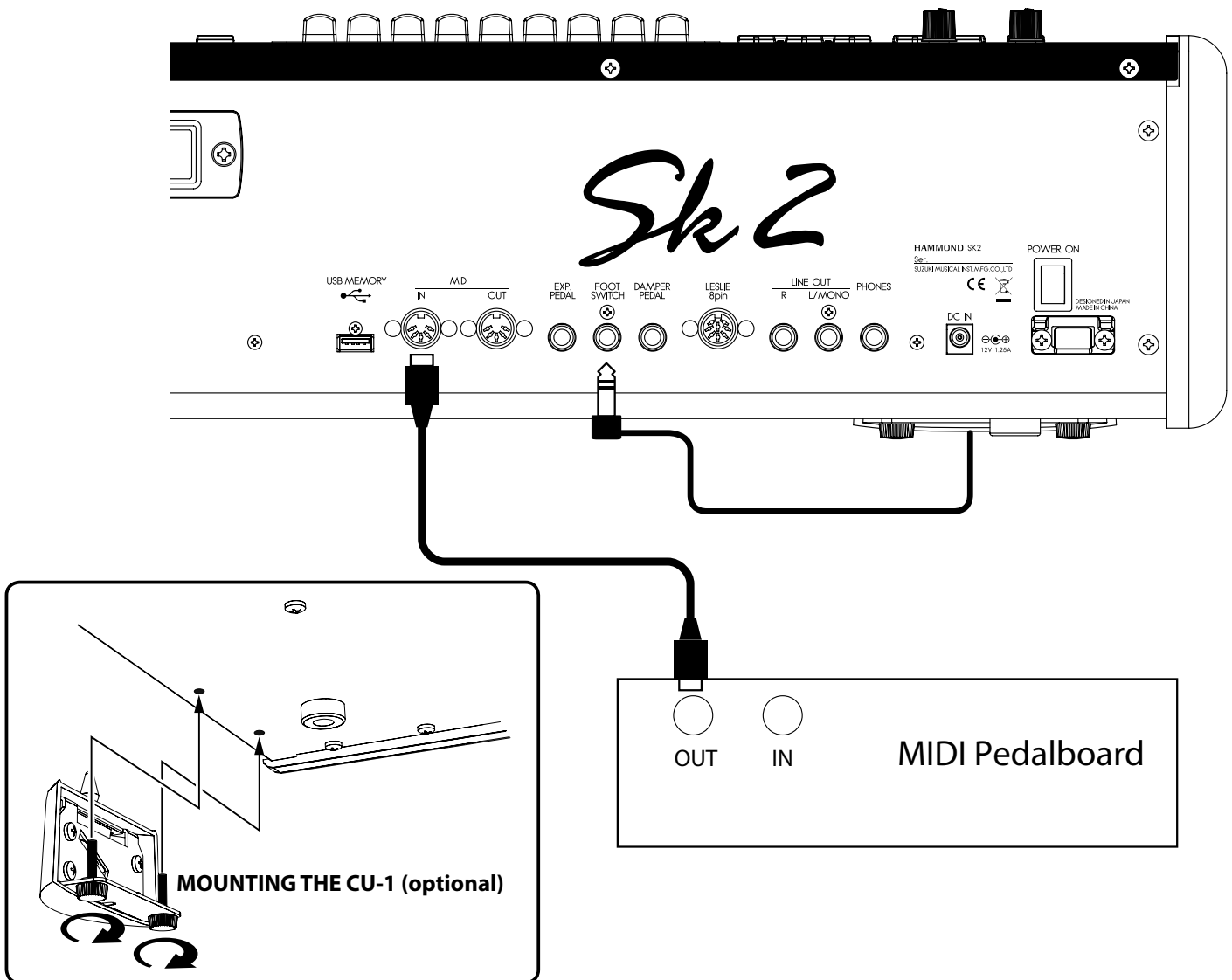

1. Connect the MIDI OUT of the MIDI pedalboard to the MIDI IN of this unit with a MIDI cable.
 2. When using a Leslie Switch CU-1, connect the CU-1 to the FOOT SWITCH jack.
- NOTE:** This illustration shows only the keyboard expansion. See P.16 for the basic hook up of the power source, audio, etc.
3. Switch ON the power of this unit and call the MIDI template “Pedal KBD”. (P. 114)
 4. When using the CU-1, set the CONTROL - FOOT DEVICE” at “CU-1”. (P. 78)

◆RECOMMENDABLE MIDI KEYBOARD

The following MIDI pedal keyboards (compliant with the SK2) are available from our sales dealers:

- ◆ MIDI pedal-board XPK-100 (13 keys)
- ◆ MIDI pedal-board XPK-200 (20 keys)

Both models have a MIDI merge function.



SWITCH ON

HOW TO POWER ON

After making the necessary connections, follow the procedures below for powering on your SK1/SK2. Please be sure to adhere to the procedure, to prevent malfunction or damage.

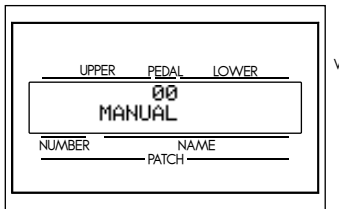
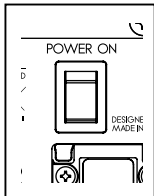
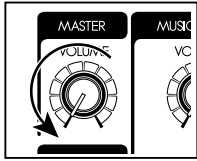

◆ PROCEDURES

1. Before switching the power ON, confirm the [MASTER VOLUME] knob is set to minimum.
2. Switch ON the [POWER] (on the rear of this keyboard). The Title mode and then the Play mode are displayed (as illustrated).
 - ❖ For protecting the circuits, the keyboard is designed not to play immediately at the power on (about 6 seconds).
3. Switch ON the connected amplifier etc.
4. Play a bit, raising the [MASTER VOLUME] knob to adjust the volume to your needs.
 - ❖ The [MANUAL] button does not sound in the default settings. Pull out the Drawbars or select any of the FAVORITE [1] to [10] buttons to get sound.
5. Adjust the volume of amplifier etc.
 - ❖ To turn OFF the power, do the above steps in reverse. (Switch OFF the amplifier etc. first.)

BACK UP

This keyboard “remembers” the unit’s status immediately before the power is turned off, returning the unit to that status upon the next power-on.

The status of the default settings are the same as when the [MANUAL] button is depressed.

RESET TO THE FACTORY SETTINGS

To reset all parameters of this keyboard to its default settings, perform the following steps:

◆ OPERATION PROCEDURES

1. Switch the [POWER] of this keyboard off.
2. Holding down the preset [RECORD] button, switch the [POWER] ON.
3. Keep holding down the button until “Loading Default...” is displayed.
4. When the Play mode is displayed, this operation is completed.

There are 100 patches loaded in memory from the factory, allowing you to immediately start playing. You can also create 100 patches of your own.

USER and PRESET

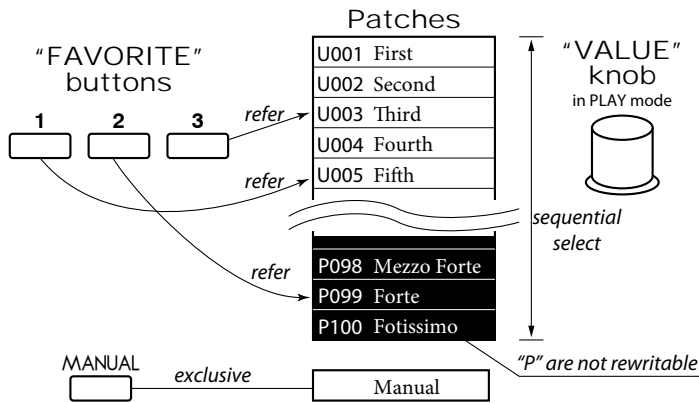

There are two domains: "USER" and "PRESET" in this keyboard's Patch memory. You can freely overwrite in the "USER" domain, but you can not do so in the "PRESET" domain as it contains the factory settings.

"USER" and "PRESET" are indicated by "U" and "P" respectively.

HOW TO CALL A PATCH

Example: Select U041.

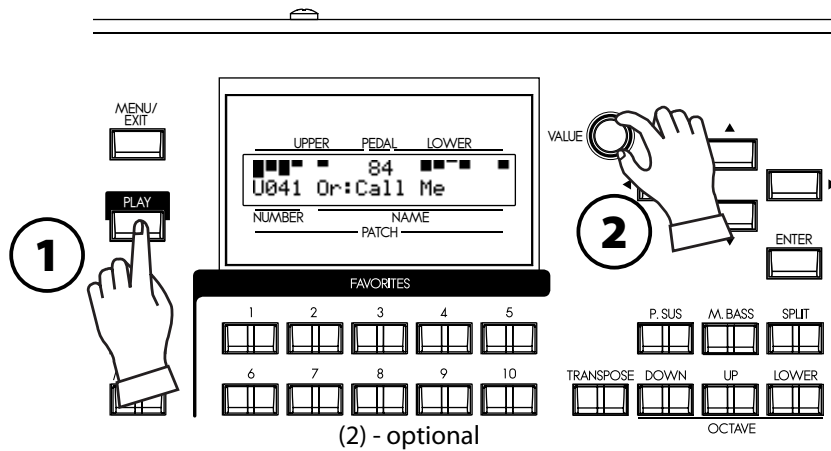

1. GO TO THE PLAY MODE

Select the PLAY button, to enter PLAY mode.

2. SELECT THE PATCH NUMBER

Select the patch number U041 with the [VALUE] knob. Read the [PRESET PATCH LIST] (P. 153) in the Appendix for the preset patch details.

Call various patches to play. When you call patches, not only the Drawbar registrations but the effects such as Leslie, reverb, and Extra Voices also change.

NOTE: You can set the types of parameters to call (P. 76 #2 to 10).

NOTE: You can set the FAVORITE buttons to select a Patch with direct key-in (P. 76 #11)

REGISTER FAVORITE PATCHES (FAVORITES)

Patches are selected with the [VALUE] knob. On stage, it is convenient to have your favorite patches available immediately. Here's how:

REGISTER PATCHES TO FAVORITES

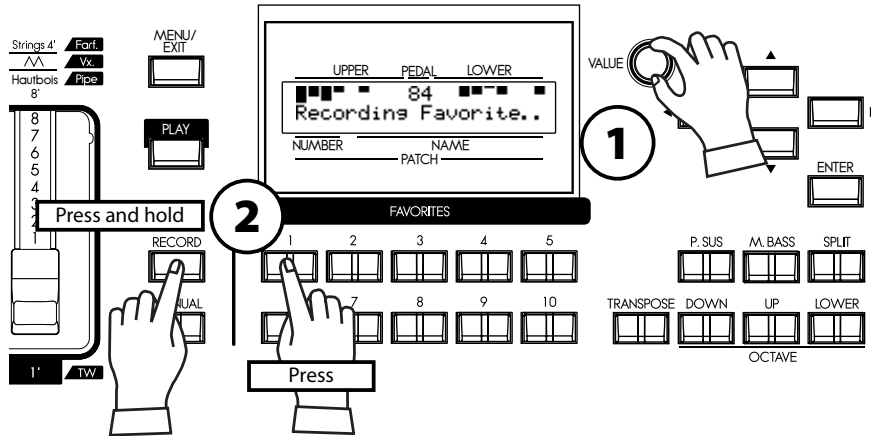

1. SELECT THE PATCH

Select the patch you want to register to a favorite button as shown on the previous page

2. SELECT THE BUTTON TO REGISTER

Press the desired Favorite button, holding down the [RECORD] button. "Recording Favorite.." is displayed for a moment and the selected Favorite button blinks momentarily. Your favorite is stored. Repeat as desired.

HOW TO CALL FAVORITES

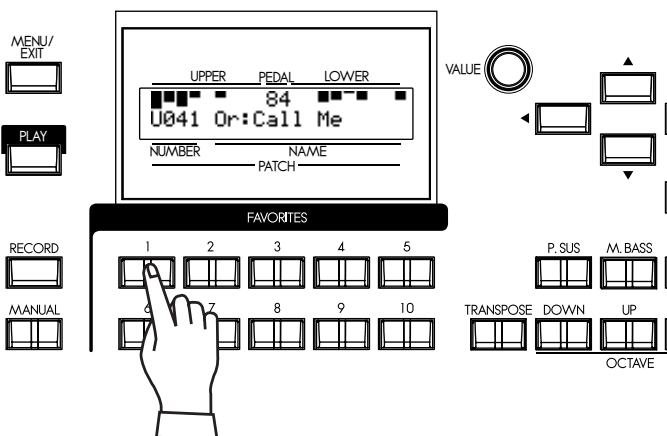

SELECT THE DESIRED BUTTON

Press the Favorite button you wish to recall. The Favorite button lights and the corresponding patch is called.

Column: RECORD FAVORITES LIKE PRESET BUTTONS

You can record a Favorite Patch with a procedure similar to the Hammond XB/XK series organs, by holding the [RECORD] button, and pressing the selected favorite button - after doing the following procedure.

1 LOCATE THE MENU MODE

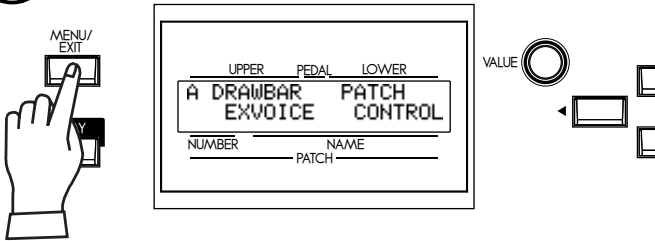

Press the [MENU/EXIT] button. The MENU mode appears. Repeat-press the menu button until the "A" menu appears (if necessary)

2 SELECT THE PATCH

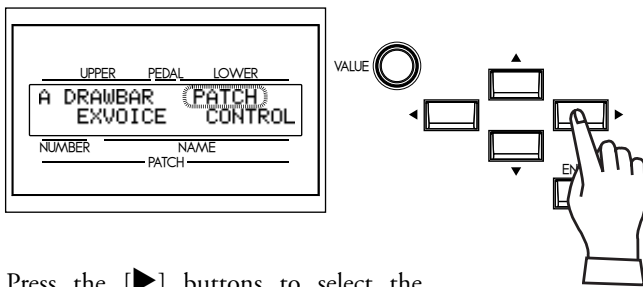

Press the [▶] buttons to select the PATCH option (it will blink).

3 ENTER

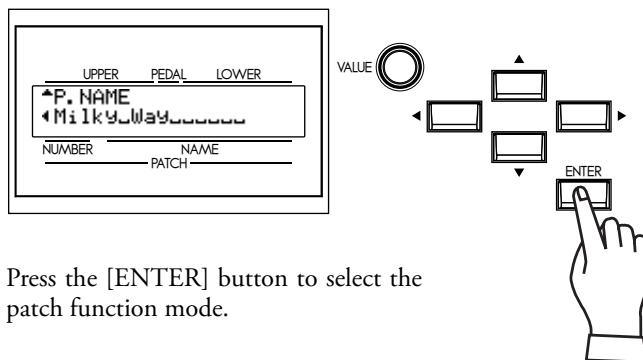

Press the [ENTER] button to select the patch function mode.

4 GO TO THE FAVORITE PAGE

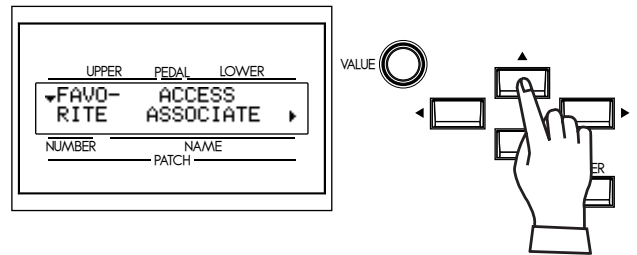

Press the [▲] button twice. The Favorite page appears.

5 SET VALUE TO LOCKED1-10

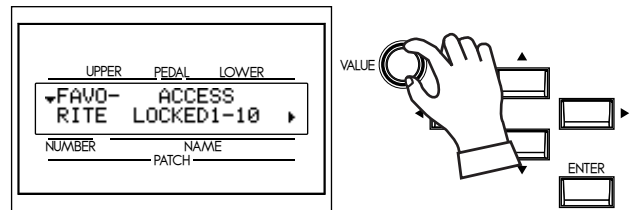

Turn the [VALUE] knob and set the value of the item RECORD to "LOCKED1-10".

6 RETURN TO THE PLAY MODE

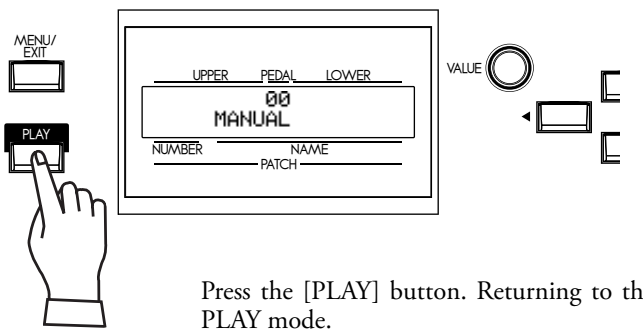

Press the [PLAY] button. Returning to the PLAY mode.

USE THE FOOT CONTROLLERS

Expression and sustain are important elements in any performance. Here you'll learn how to connect these controllers.

EXPRESSION PEDAL

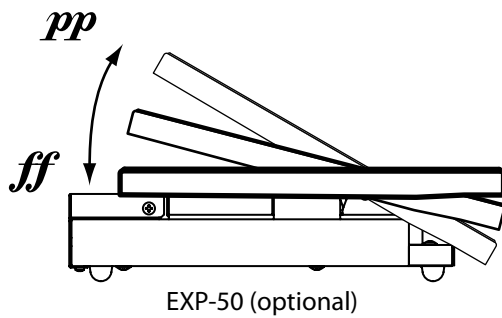

The Expression Pedal controls the overall volume or loudness of the SK1/SK2. The further you depress the pedal, the louder the sound becomes; the more you pull back on the pedal, the softer it.

NOTE: The Volume pedal has specific parameters to adjust. (P. 26)

NOTE: You can switch enable or disable of which control the Extra Voice section. (P.77)

FOOT SWITCH

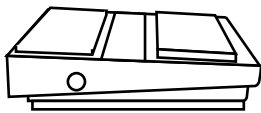

FS-9H (optional)

The foot switch can be programmed to various functions. The default setting is [LESLIE S/F ALTERNATE]. Every press toggles, the speed of the Leslie effect to fast or not.

NOTE: You can change the foot switch assignment. (P. 78)

Every room has a different acoustic profile, and it is often necessary to compensate for this. The SK's MASTER EQUALIZER allows you to tailor the overall tonal profile of your instrument without changing the contents of the Patches.

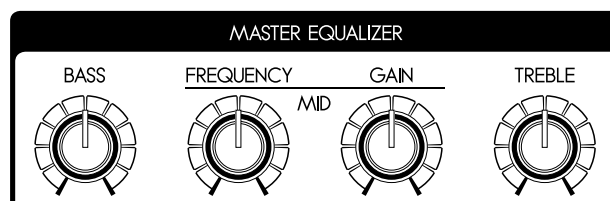

BASS

Controls the Bass frequencies. It is adjustable below 100Hz by ± 9 dB. The response is flat in the middle.

MID FREQUENCY

Controls which Mid-range frequency will be adjusted by the MID GAIN knob. The range is between 250Hz and 3.1kHz.

MID GAIN

Controls the gain of the frequency set by the MID FREQUENCY knob. The response is flat at the center.

TREBLE

Controls the treble frequencies. Adjustable above 4kHz by ± 9 dB. The response is flat in the middle.

❖ *The sound may distort if gains are raised too high. Adjust accordingly.*

NOTE: These are live performance controls, and they are not record to Patch memory.

NOTE: You can change the corner frequency of BASS and TREBLE(P. 100).

TRY CREATING YOUR OWN SOUND

In this section you'll learn how to create your own sound. In this example, the Organ and Extra Voices are combined (Jazz Organ and Electric Piano).

SELECT [MANUAL]

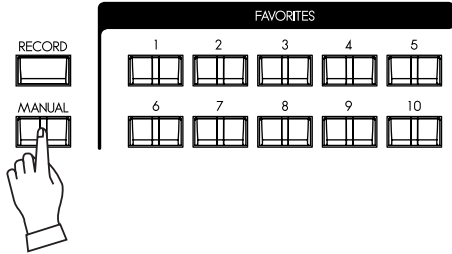

First, select the [MANUAL] button (LED lit).

The [MANUAL] button makes all the current control panel settings active, allowing for real-time registration, and the creation of new patches.

NOTE: To return to the Patch, press the [MANUAL] button again (LED off).

Column: INITIALIZE THE INTERNAL SETTINGS [MANUAL]

When the MANUAL button is pressed, not only the current panel settings become active, but the internal settings do as well. This is the procedure to return them to the DEFAULT Status.

1 GO TO THE MENU MODE

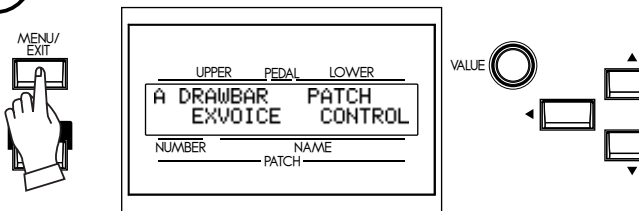

Select the [MENU/EXIT] button. The Menu mode appears. If the display is different from the above illustration, select the [MENU/EXIT] button again.

2 LOCATE PAGE E

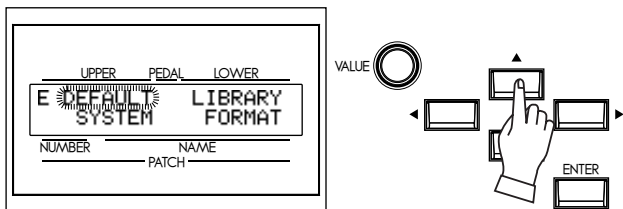

Press the [▲] button 4 times reaching Page E. The DEFAULT entry is blinking.

3 ENTER

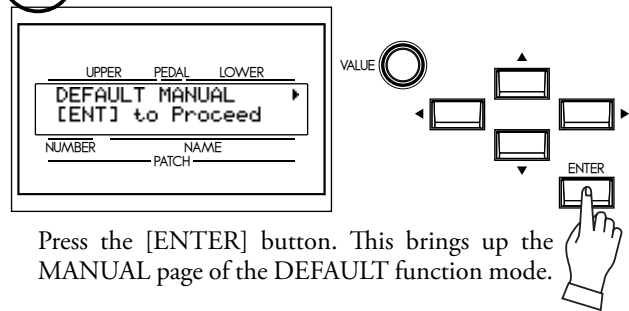

Press the [ENTER] button. This brings up the MANUAL page of the DEFAULT function mode.

4 ENTER AGAIN

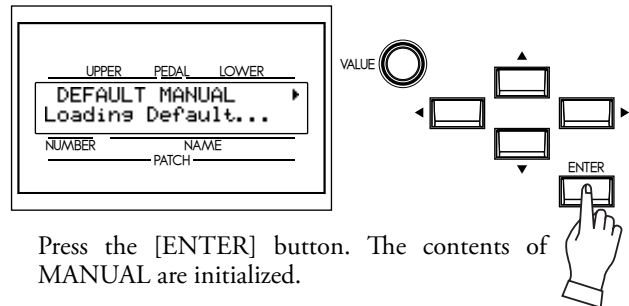

Press the [ENTER] button. The contents of MANUAL are initialized.

5 RETURN TO THE PLAY MODE

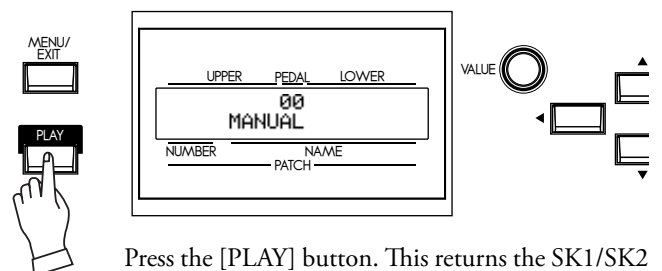

Press the [PLAY] button. This returns the SK1/SK2 to the Play mode.

SELECT THE UPPER DRAWBARS

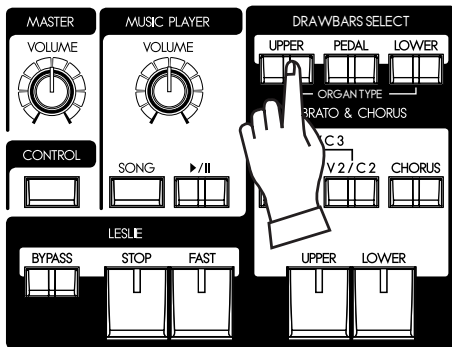

In this example, make sounds to begin with the Organ Section. The DRAWBARS SELECT buttons are for selecting which part the Drawbars will control written below.

NOTE: What is a "PART"? (p. 33)

Select [UPPER]. This is the basic Organ Part, the one used most frequently.

PULL OUT DRAWBARS

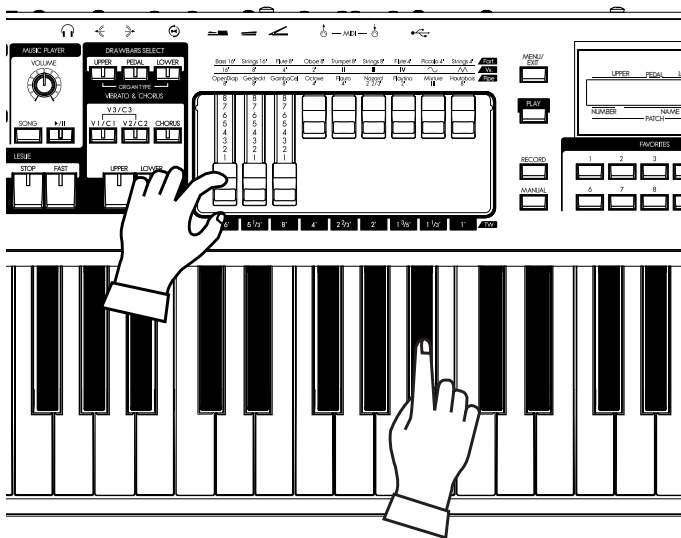

Pull out Drawbars to your taste. You can monitor your selections easily while playing the keyboard (the UPPER keyboard if on SK2).

The Drawbars make the fundamental organ sound of this unit. The tone changes depending on how far the Drawbars are pulled out.

The volume of each sound becomes maximum when the Drawbar is fully pulled out, and null when fully pushed back. The drawbars are arranged so that the pitch grows higher from left to right.

Now, as an example, fully pull out the 3 left side bars; 16', 5 1/3' and 8'.

NOTE: You can change the sound character of the Drawbars. (P. 74)

NOTE: The present registration is displayed in the Play mode. (P. 65)

ADD THE TOUCH-RESPONSE PERCUSSION

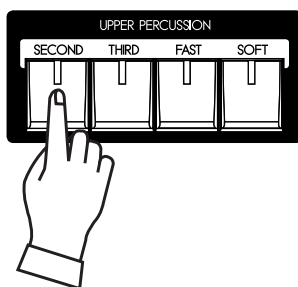

[PERCUSSION] here does not mean percussion instruments like drums or marimbas, but the classic crisp attack unique to the Hammond Organ. Use it to mix with Drawbar sounds whenever necessary. [PERCUSSION] is available only on the UPPER part.

If you switch on the [SECOND] and the [THIRD], percussion sounds of one octave higher "C" and "G" are added to the note on each keyboard, respectively.

If you switch on the [FAST] button the decay is quicker, and if the [SOFT] button is selected, the volume of the Percussion is diminished.

Here, select the following 3 Percussion buttons [THIRD], [FAST], [SOFT].

NOTE: You can fine-tune the percussion parameters to your taste. (P. 82)

ADD EFFECTS TO THE ORGAN SECTION

VIBRATO & CHORUS

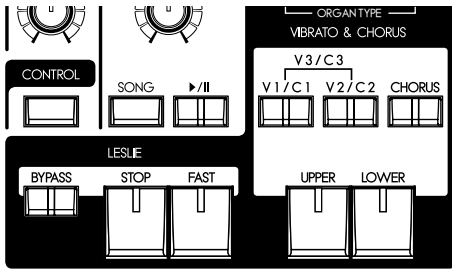

Adding the Classic Hammond Vibrato & Chorus to the sound.

[UPPER], [LOWER] buttons

Switches the Vibrato & Chorus effect ON/OFF. When ON the light illuminates.

[V1/C2], [V2/C2] buttons

These set the depth of the Vibrato effect. If both buttons are selected, the depth becomes maximum as V3/C3.

[CHORUS] button

This button changes the Vibrato to the distinctive and Classic Hammond Chorus effect—Changing the V1/V2/V3 to C1/C2/C3. When the Chorus effect is engaged the button light illuminates.

NOTE: You can fine-tune the speed of Vibrato/Chorus. (P. 83)

For this example, set ALL of the Vibrato & Chorus buttons to “on” (except [LOWER]).

LESLIE

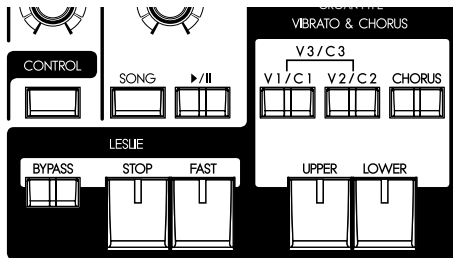

The LESLIE effect is the famous “Moving and Swirling” sound provided by rotating horns and speakers, but executed here in the Digital realm.

[FAST] button

This button toggles the mode of the rotor to fast or not. When the light is ON, it is FAST, and when OFF, not.

[STOP] button

This button sets the mode when the [FAST] button is off. When the light is ON, it is STOP, and when OFF, it is SLOW.

[BYPASS] button

To Engage the Leslie effect, press the [BYPASS] button turning the light OFF.

NOTE: These controls perform the same functions when a Physical Leslie is connected via the 8 pin plug.

NOTE: You can fine-tune the parameters of the Digital Leslie effect etc. (P. 84)

For this example, let’s set the status of all lights OFF.

OVERDRIVE

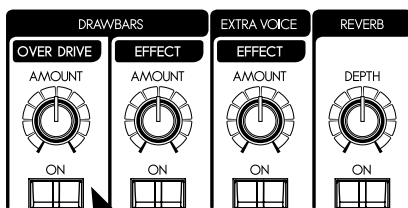

The overdrive section adds warmth at low settings, and “grit” or distortion at higher.

[ON] button

Toggles the Overdrive OFF and ON (when on the light is illuminated).

[AMOUNT] knob

Adjusts the amount of Overdrive. The amount increases as you rotate the knob clockwise.

In this example, the Overdrive is not used. The Button light should be OFF.

MULTI-EFFECTS

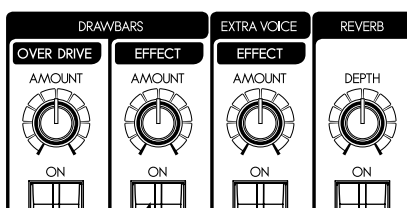

Adjusts the amount of the Chosen Multi-effect to be applied to the Drawbar sounds. The default settings: at “Tremolo”.

[ON] button

Toggles the Multi-Effects send ON and OFF (The light illuminates when ON).

[AMOUNT] knob

Adjusts the amount of Multi-Effect to be applied. The amount increases as you rotate the knob clockwise.

In this example, the Multi-Effects are not used. The Button light should be OFF.

ALLOCATING THE EXTRA VOICES

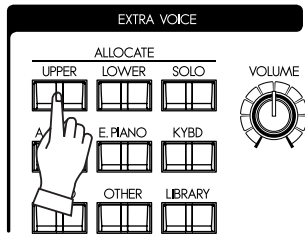

Choose which parts will play the Extra Voices.

[UPPER] button

The Extra Voices play in the UPPER part.

[LOWER] button

The Extra Voices play in the LOWER part.

[SOLO] BUTTON

Turns the Organ section OFF and only the Extra Voices sound.

In this example, a blend of Organ and Piano voices are desired. Press the [UPPER] button ON, and insure the [LOWER] and [SOLO] buttons are not lit.

SELECT AN INSTRUMENT

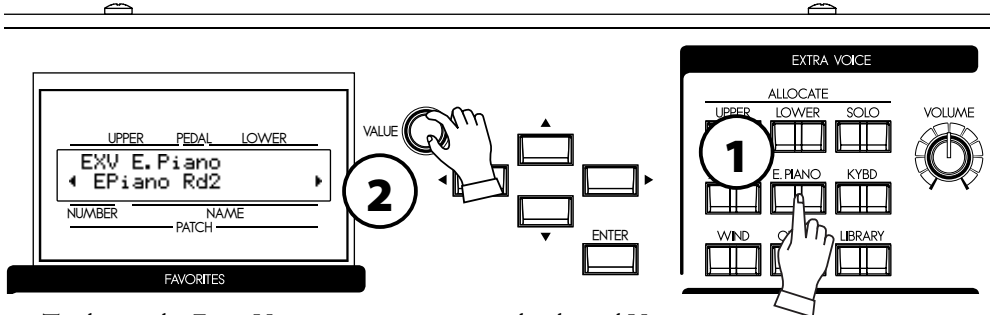

To choose the Extra Voice instruments, press the desired Voice Group button on the top panel, then select your specific instrument in the display.

Select the “EPiano Rd2” as follows.

1. SELECT A VOICE GROUP

Press the [E.PIANO] button.

The instrument automatically selects voice used previously in this voice group.

The voice will appear in the display.

2. SELECT AN INSTRUMENT

Select “EPiano Rd2” with the [VALUE] knob.

Now the “EPiano Rd2” is ready to play.

Column: To select the “A. Piano 2”

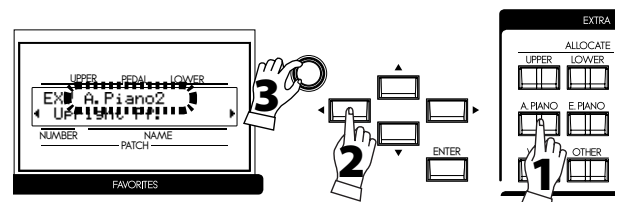

The voice group “A. Piano 2” is hidden behind the [A.PIANO] button. To select this;

1. Press the [A.PIANO] button.
2. Locate the cursor at voice group with the [◀] button.
3. Select the “A.Piano2” with the [VALUE] knob.
4. Locate the cursor at instrument with the [▶] button. or, Press the [A.PIANO] button again after step 1.

ADJUST THE VOLUME BALANCE

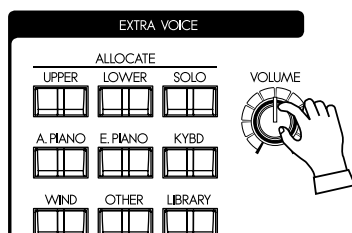

To achieve your desired blend of Organ and Extra Voice (In this example the E. Piano), adjust the Extra Voice volume knob accordingly.

ADD EFFECTS TO THE EXTRA VOICE SECTION

MULTI-EFFECTS

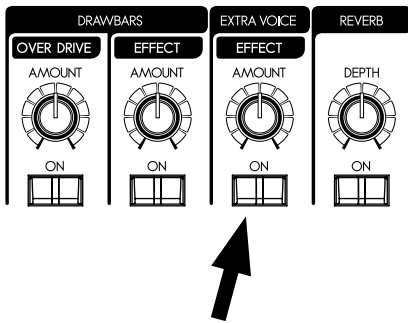

The most suitable effects for each Extra Voice are automatically called when selecting that voice.

[ON] button

Adds effects to the Extra Voices. When “ON” the light is illuminated.

[AMOUNT] knob

Adjusts the amount of effect added. Turning the knob clockwise increases the amount.

ADD REVERB TO BOTH SECTIONS

REVERB

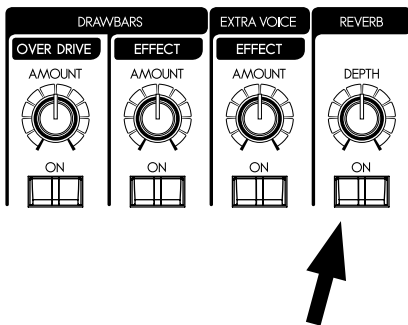

The SK1/SK2’s Digital Reverberation is common to both Organ and Extra Voice sections.

[ON] button

Turns the Reverb effect ON.

[DEPTH] knob

Adjusts the amount of Reverb added. Turning the knob clockwise increases the amount.

WHAT IS A “PART”?

Each “PART” is equivalent to a player in a band or an orchestra. The 3 Parts here are expressed in Organ terms: UPPER, LOWER, and PEDAL. These parts can be individually played with different sounds.

The SK1 has a single keyboard, the SK2 has 2 keyboards. Plural parts are available simultaneously, by splitting the keyboards or expanding them using a MIDI keyboard.

KEYBOARD SPLIT

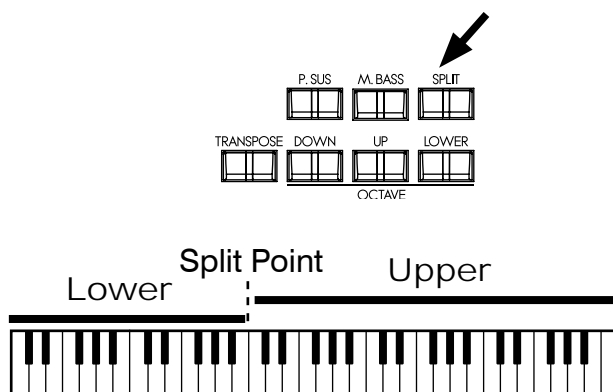

The SK1 has only 1 manual, but it can be split and treated as if it were a 2 manual instrument.

[SPLIT] button

To use the Split function, press the [SPLIT] button and the light will go ON. The default setting split is at the middle B/C.

NOTE: You can change the split point (dividing note) and octave. (P. 112)

NOTE: The Split function is disabled when a second MIDI Keyboard is added. (P. 114)

Right of the split point is referred to as: UPPER and the left side LOWER. Percussion does not function on the LOWER part.

There is no SPLIT function available on the SK2.

MANUAL BASS

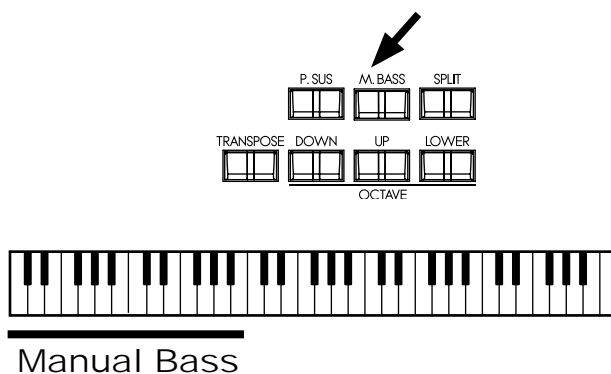

You can play the Pedal voices using the lowest notes of the keyboard (the LOWER keyboard if on the SK2).

[M. BASS] button

To use the Manual Bass function, press the [M. BASS] button and the light will go ON. The Pedal/Bass sound is heard in conjunction with the lowest note being played, on the manual keyboard till that time.

In order to interface with the melody performance, the default Manual Bass upper limit point is set to sound up to, and including middle “B”.

NOTE: The Manual Bass can be set to play in Lowest, Polyphonic, and Chord (P. 112 #1). You can change the playing range of the Manual Bass (the upper limit) (P. 112 #2).

NOTE: When the SK1 is expanded to 2 manual, the Manual Bass function works on the LOWER keyboard. (P. 114)

The part obtained when the Manual Bass is selected is called PEDAL part and its sound is controlled by the Drawbars ([PEDAL] when selected in Drawbar Select). This is originated from the style of playing bass on the pedal keyboard of a 3 keyboard type organ.

You can use both the manual bass and the split at the same time. This makes it possible to play the bass + chord + melody only by yourself.

NOTE: You can triggering the Manual Bass by foot switch (P. 78).

LOWER TO PEDAL

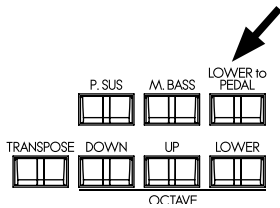

Lower to Pedal

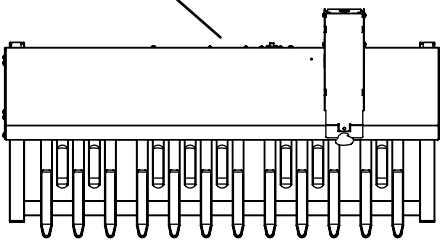

When a pedal keyboard is connected to the SK2, you can play the LOWER part sound (or “registration”) with the pedalboard using the “LOWER TO PEDAL”.

[LOWER to PEDAL] BUTTON

To use the ‘Lower to Pedal’ coupler, press the [LOWER to PEDAL] button and the light will go ON.

The default upper limit for Lower to Pedal is below Middle “B”.

NOTE: You can change the playing range (the upper limit) of the ‘Lower to Pedal’. (P. 112 #2)

PEDAL SUSTAIN

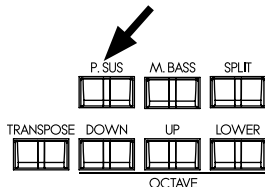

A popular effect for organ bass is “PEDAL SUSTAIN”, which adds a smooth decay reminiscent of a string bass.

[PEDAL SUSTAIN]

To engage the pedal sustain, press the [P. SUS] button and the light will go ON. When you release your foot from the pedalboard (or release the key on the Lower keyboard - when using manual “Bass”), the PEDAL part decays smoothly.

NOTE: You can adjust the sustain time of the Pedal Sustain. (P. 75 #16)

RECORD THE PATCH TO MEMORY

All the previous settings can be recorded to any Patch within the range of U001 to U100.

Example: RECORD TO U032

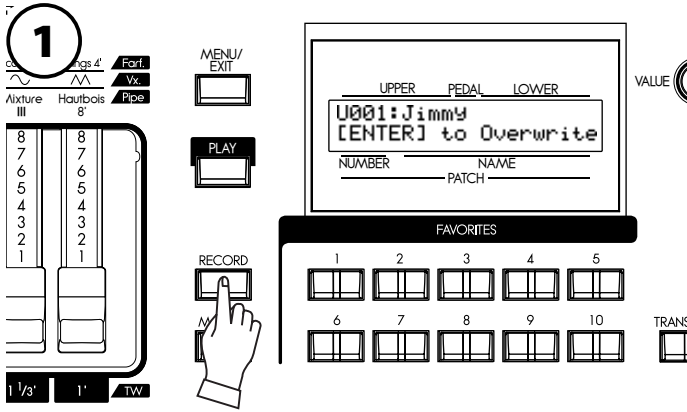

Press the [RECORD] button.

A question “Which patch do you want to record?” appears in the display.

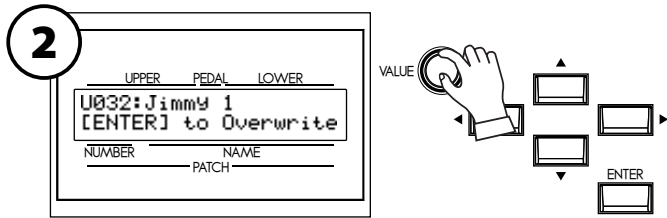

Select the patch number, this time U032, to record, using the [VALUE] knob.

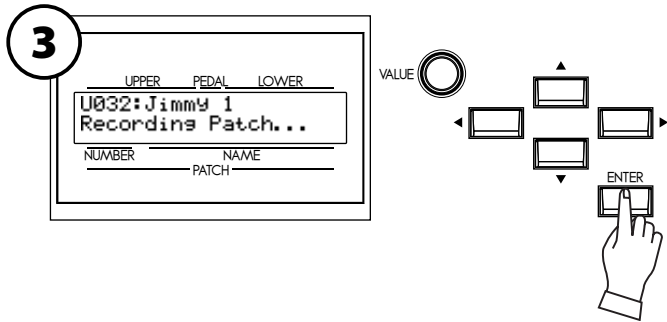

Press the [ENTER] button.

The Patch Number is decided and “Recording Patch” is displayed. When the recording process completes, the display returns to the previous mode.

The recorded patch is automatically selected.

NOTE: The user created patch data is not lost when the power is turned off and/or disconnected.

LOCKING THE DISPLAY

You can lock the display to avoid mistake while playing.

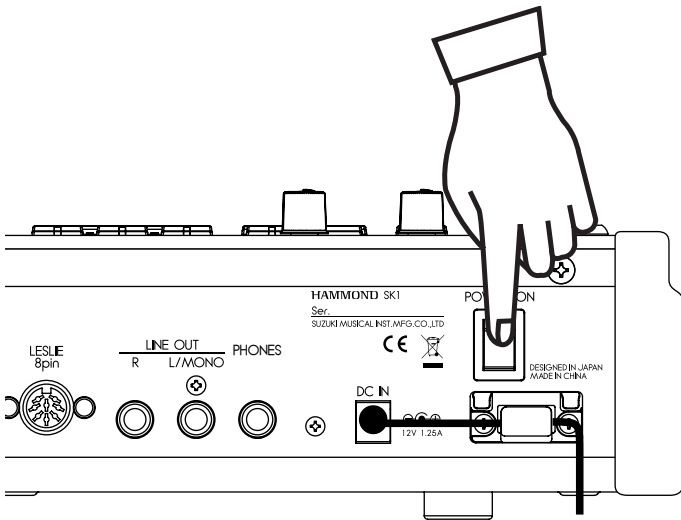
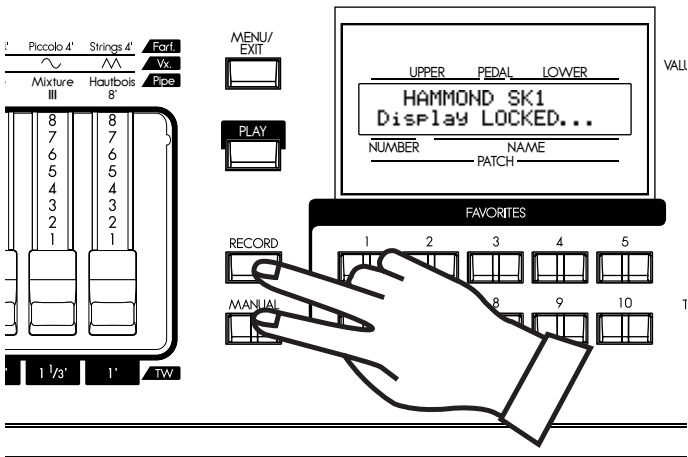

To lock the display, switch [POWER] on with pressing [RECORD] and [MANUAL] until “Display LOCKED” is displayed.

To unlock this, repeat the operation above until “Display UNLOCKED” is displayed.

This function works listed below;

- ◆ [MENU/EXIT] button (P. 66) is disabled
- ◆ [RECORD] button (P. 35) is disabled normally, but you can record the patch by using “LOCKED 1-10” (P. 25), or you can associate the favorite buttons by using “ASSOCIATE” (P. 76) before locking the display.
- ◆ “Short-Cut” function (P. 69) is disabled
- ◆ [DRAWBAR SELECT] buttons (P. 49) are still enabled.
- ◆ [EXTRA VOICE] buttons (P. 31) are enabled, but the page or cursor is locked on the instrument name.

NOTE: This feature will not be released by Default-All or power on with pressing [RECORD] button.

tips USING REGISTERED PAGE

The [CONTROL] button can register a page in function mode. Even if it locked the display, you can enter the registered page by using [CONTROL] button.

However, you cannot move the cursor if the page has 2 or more parameters.



SOUND ENGINE STRUCTURE

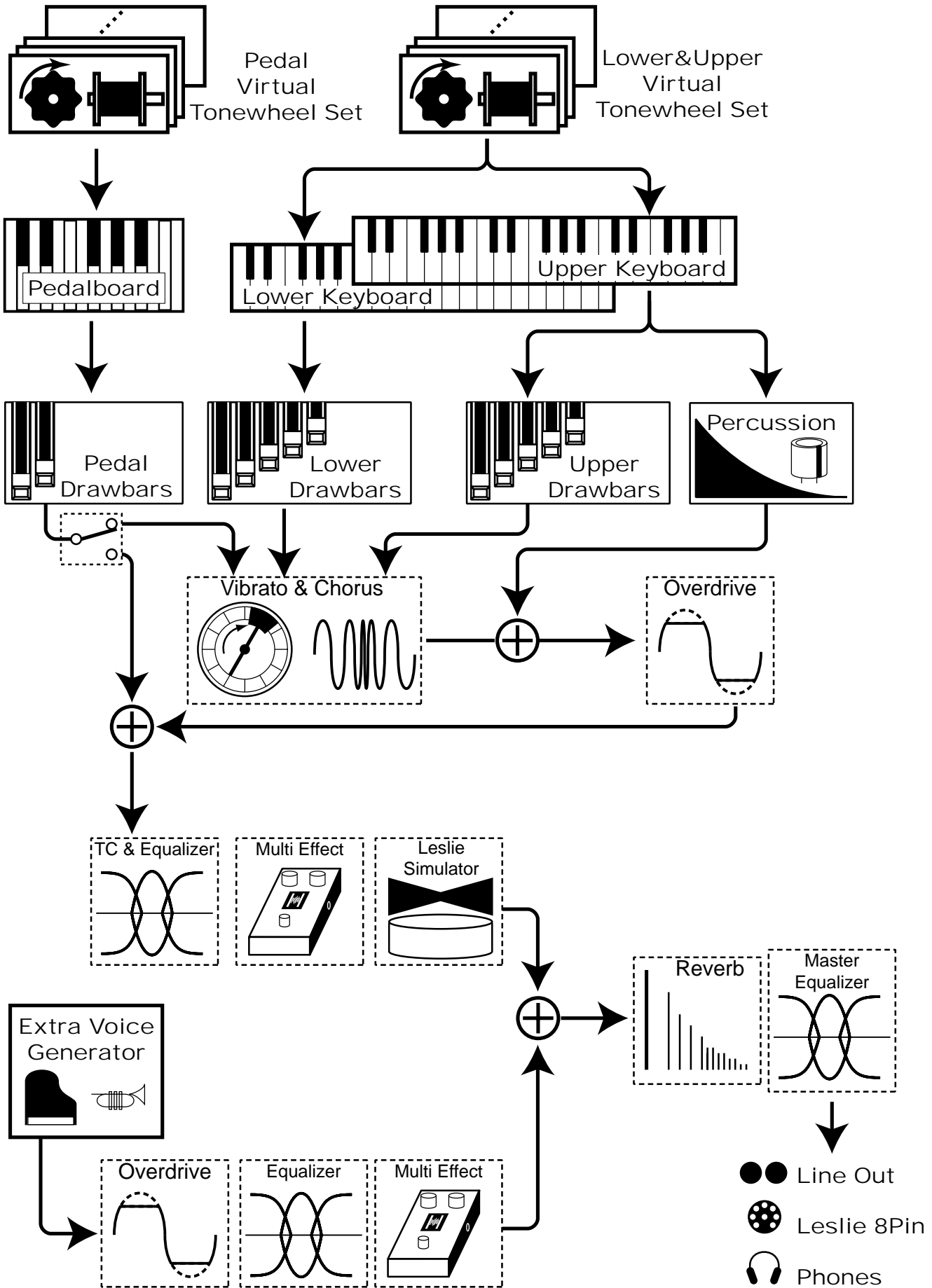

To fully utilizing this unit, read the following detailed explanations about the various functions for creating music.

ORGAN SECTION

TONE-WHEELS

The sound source or “engine” of the classic Hammond Organ are the electro-magnetic Tone-Wheel Generators. On this keyboard, the Tone Wheel engine is replicated digitally. While the power is on, each of the 96 virtual Tone-Wheels keeps oscillating as they did in the vintage Hammond Organs.

KEYS

The tone signals created with the 96 virtual Tone-Wheels are “switched” at the keys. To each key the signals corresponding to the pitch and harmonics (for example, 9 sets on the manual keyboard) are distributed, and when you touch or release a key, the switch connects or cuts the tone signals.

DRAWBARS

Each Drawbar represents a fundamental harmonic. Each bar adjusts the value of each harmonic. There are 9 drawbars corresponding to 9 different harmonics.

TOUCH-RESPONSE PERCUSSION

The Percussion creates a decaying sound on the UPPER manual.

VIBRATO & CHORUS

The Vibrato & Chorus gives depth and richness to the organ sound by slightly varying the pitch (Vibrato), or doubling the voice by mixing the original sound, with a duplicate, slightly detuned one (Chorus).

OVERDRIVE

The Overdrive creates distortion as if an amplifier was being driven beyond its limits.

MULTI-EFFECTS

The Multi-Effects create various effects such as tremolo and Wah.

EQUALIZER, LESLIE, REVERB

The built-in Effects are as follows: an Equalizer for sculpting the tonal response, a Leslie Effect for rotary speaker effects, and Reverb.

(The built-in Leslie Effect is disengaged when a physical Leslie is connected to the 8-pin terminal.)

EXTRA VOICE SECTION

SOUND ENGINE

The Extra Voice section is the sound engine for playing piano and other musical instruments. It is independent of the Organ Section.

EFFECTS

You can add Overdrive, Multi-Effects, Equalizer and Reverb to the Extra Voice Section.

MASTER EQUALIZER

The combined signal of Organ and Extra Voice is routed through the Master Equalizer. Allowing you to tailor your sound for the provided venue, amp, sound system or recording. The settings are not saved in patch memory.

tips TONE-WHEEL SETS

The Tone-Wheel Sets are divided into the Manuals and the Pedal Part. This is to give the Pedal Part the Decay (= the sound gradually fading out while pressing the key) or Sustain Effect. (= the sound gradually fading out after the key is released).

tips HARMONICS

Harmonic is a pitch of a different ratio to a certain pitch; for example, the one octave higher C to the middle C. The more Harmonics, the brighter and richer sound is obtained.

ORGAN TYPE

There are various "Organ" types: the Hammond Tone-Wheel organs used in everywhere rock, jazz, and Gospel, the transistor organ frequently heard in pop music of '60's. Classical pipe organ used in classical music or church services. All organs have characteristic sounds.

The keyboard will sound like the types of organ you choose.

STONE-WHEELS (BType1, BType2, Mellow)

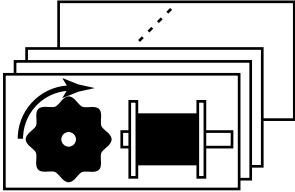

These are various types of Hammond Organs' characteristic tone wheels. The Hammond Organ's original purpose was to duplicate the pipe organ, however, they became famous for producing a unique sound of their own.

The BType1 and BType2 have the B-3/C-3's traditional Tone-Wheel sounds. The BType2 has more wow-flutter and leakage noise.

The Mellow is not a Tone-Wheel, if strictly speaking. It replicates the first-generation non-mechanical Transistor Hammond Tone Generators like the GT-7 and Concord.

TRANSISTOR (Vx, Farf)

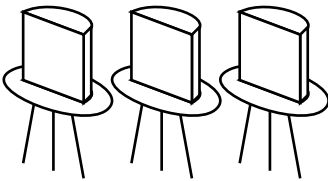

After the transistor became generally used, the light weight organs were introduced (such as Ace Tone TOP-6 etc.) using the transistor circuit instead of the tone wheels or tubes. The circuit system is different from maker to maker or model by model. We have replicated 2 representative types here.

The Vx is a type to combine the triangle wave and square wave with several footages. The Farf is one to combine the sound wave forms coming through plural filters with the tablet switch.

PIPE

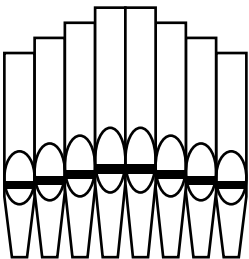

The pipe organ produces sounds by oscillating the air sent through the pipe. The name of Stops tells you which wind instruments that you are duplication.

You can create other sounds by combining different organ Stops, in the same way Drawbars are used on this keyboard.

Column: SELECTING THE ORGAN TYPES

Use the control panel for switching the organ types.

Example: Switching the manual part to “Pipe”

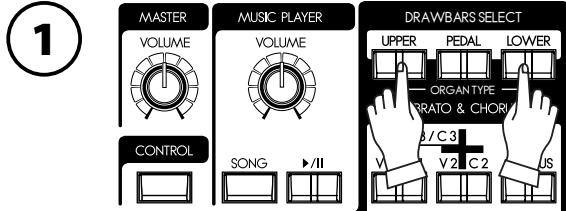

Press the [UPPER] and [LOWER] buttons together. The DRAWBAR function mode is displayed and the organ type (“BType1” etc.) of the manual keyboard presently selected blinks.

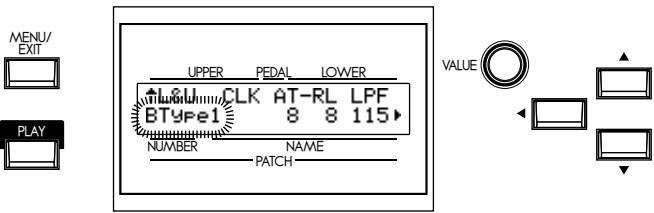

Select “Pipe” with the [VALUE] knob. The pipe organ sounds when you play the keyboard.

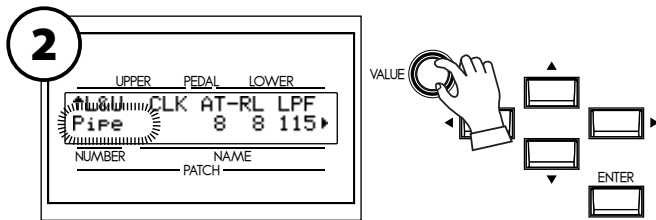

To return to the PLAY mode, press the [PLAY] button.

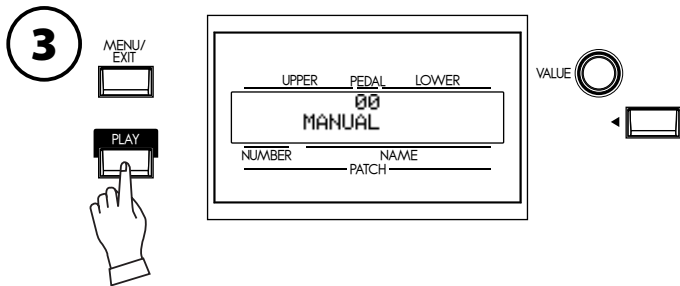

HARMONIC DRAWBARS™

The 9 Drawbars on this keyboard are used to create the basic “Hammond” sounds. Each Drawbar is marked with the register numbers 1 - 8 along the flat part of the Drawbar. If you push back a Drawbar until you cannot see any number at all, the sound of the Drawbar is not heard. If you pull it out to the fullest position the sound level is maximum.

When recalling a patch, the drawbars’ “positions” will change internally, but not physically. However, if you move a drawbar, the setting will “snap” to that drawbars current position.

DRAWBARS (ON TONE-WHEEL)

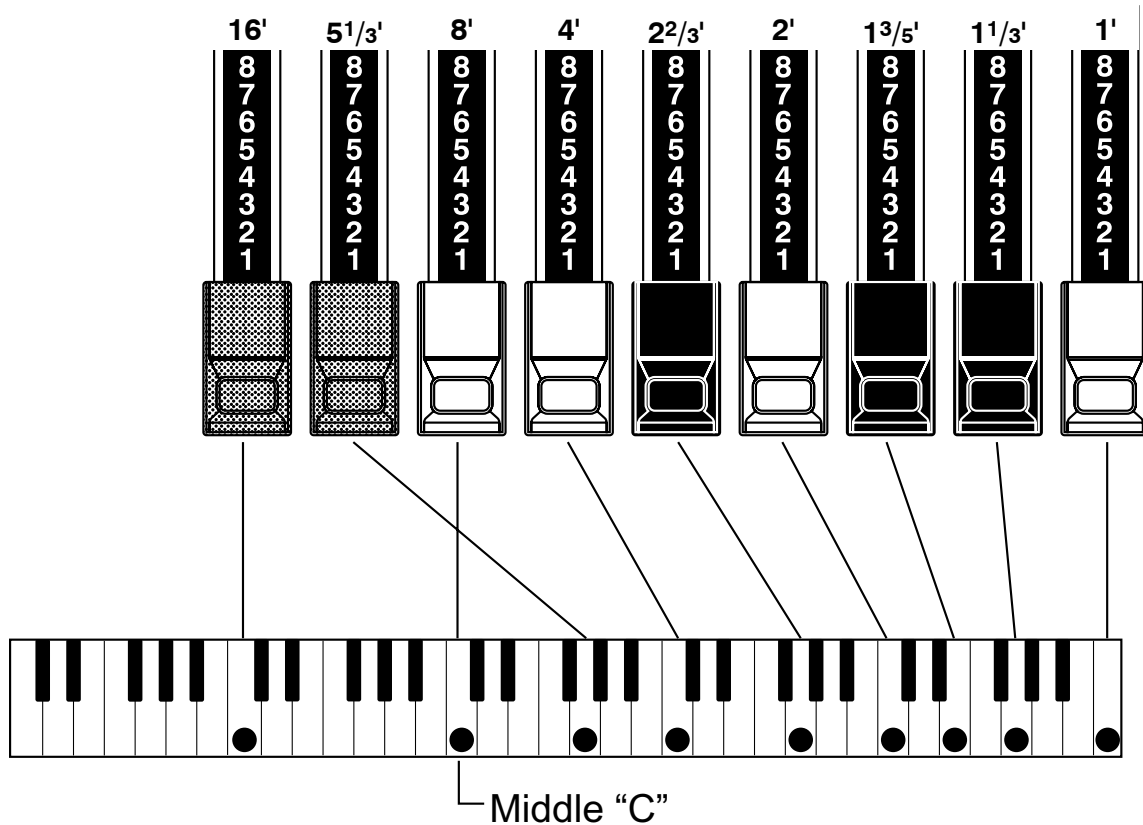

The pitch of each Drawbar is as shown above, when the middle C is depressed. The footage marked (') on the handle end of each Drawbar is derived from the corresponding length of pipes of a pipe organ.

The numbers 1 - 8 on the “bar” portion of each Drawbar indicate the volume of the sound to be produced as well as the guide to remember Drawbar settings.

Pull the fundamental (8'), the third harmonic ($2\frac{2}{3}'$) plus the fifth harmonic ($1\frac{3}{5}'$) Drawbars out completely and play the keyboard. Notice how the sound resembles a clarinet.

If you push the 8' Drawbar half-way, you'll notice the sound becomes more high-pitched and a bit “harder”. Now pull the 8' Drawbar back out fully and push the $2\frac{2}{3}'$ and $1\frac{3}{5}'$ in halfway. Notice how the sound becomes mellower.

Experiment with the Drawbars to obtain your own personal favorite sounds.

tips DRAWBAR RESISTRATION

The lengths of the pulled out Drawbars.

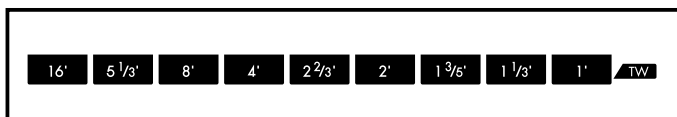

In the case of the Tone-Wheel Organ, refer the correspondence between each bar and the footage to the “TW” row in front of the Drawbars.

DRAWBARS FOR THE UPPER AND LOWER PARTS

WHITE DRAWBARS

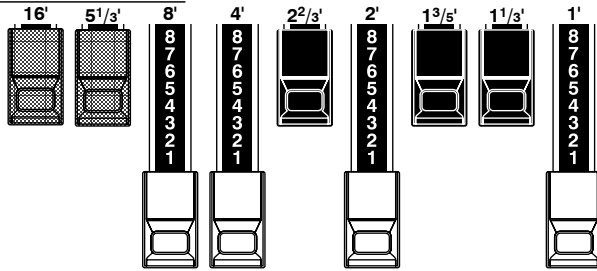

In each Drawbar set, the white Drawbar (8') on the left side makes the fundamental sound. The other white Drawbars get higher by the octave to the right.

BLACK DRAWBARS

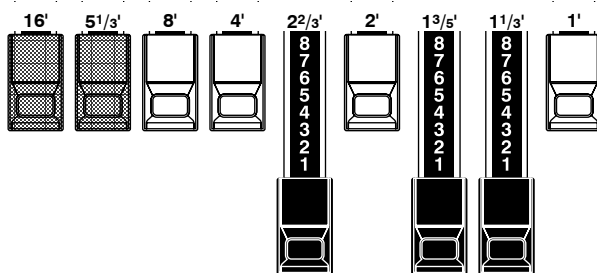

The sounds of the black Drawbars, too, play an important role in building rich tones. Their pitches are fifth and third to the fundamental. These harmonics add a complexity to the tone, even allowing characteristics of acoustic instruments.

BROWN DRAWBARS

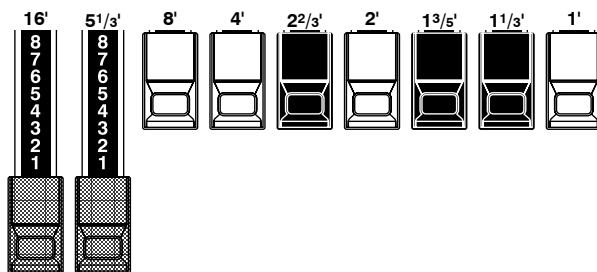

The two brown Drawbars on the far left give depth and richness to the sound. The left 16' is one octave lower than the 8', and 5 1/3' is the third harmonic of the 16' fundamental. Normally, the tones are built on the 8' fundamental, but, if you want to add depth to the tone or to expand the playing range by one octave lower, build your tones on the 16' fundamental.

DRAWBARS TO USE ON THE PEDAL

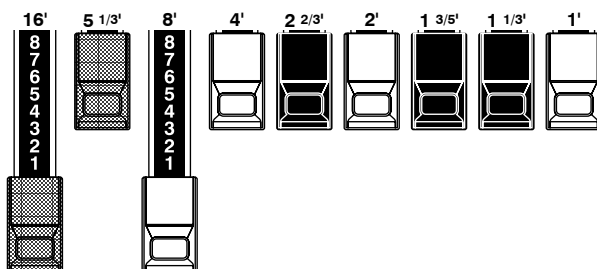

The Pedalboard plays the bass line and uses the two Drawbars -16' and 8'. The first Pedal Drawbar produces a tone at 16' pitch for a deep foundation bass, while the second Pedal Drawbar produces a tone at 8' pitch, or one octave higher.

The registration of the Pedal part appears in the center of the display. 16' on the left and 8' on the right.

DRAWBAR REGISTRATION PATTERNS

The Drawbar Registration is matched by digits. It is easy to remember the typical combinations of the 9 Drawbars by their forms.

The Drawbar Registrations are grouped into the following 4 patterns:

Flute family (2 step pattern)

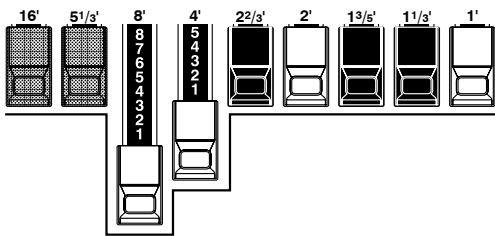

Accompaniment Flute 8' I.....	00 8460 000
Accompaniment Flute 8' II.....	00 3220 000
Accompaniment Flute 8' III.....	00 8600 000
Chorus of Flutes 16'.....	80 8605 002
Orchestral Flute 8'.....	00 3831 000
Piccolo 2'.....	00 0006 003
Stopped Flute 8'.....	00 5020 000
Tibia 8'.....	00 7030 000
Tibia 4'.....	00 0700 030
Tibia (Theater) 16'.....	80 8605 004
Wooden Open Flute 8'.....	00 8840 000

Diapason family (check mark pattern)

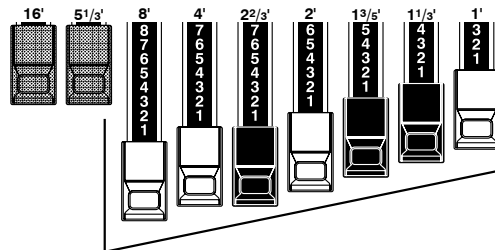

Accomp. Diapason 8'.....	00 8874 210
Chorus Diapason 8'.....	00 8686 310
Diapason 8'.....	00 7785 321
Echo Diapason 8'.....	00 4434 210
Harmonic Diapason 16'.....	85 8524 100
Harmonic Diapason 8'.....	00 8877 760
Harmonic Diapason 4'.....	00 0606 045
Horn Diapason 8'.....	00 8887 480
Open Diapason 8'.....	01 8866 430
Solo Diapason.....	01 8855 331
Wood Diapason 8'.....	00 7754 321

Reed family (triangle pattern)

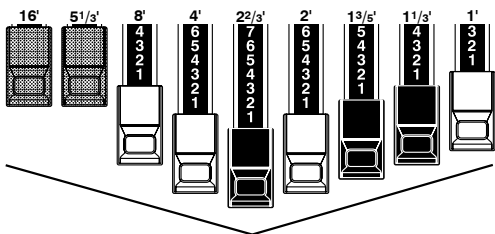

Bassoon 16'.....	44 7000 000
Clarinet 8'.....	00 6070 540
English Horn 8'.....	00 3682 210
Flugel Horn 8'.....	00 5777 530
French Horn.....	00 7654 321
Kinura 8'.....	00 0172 786
Oboe 8'.....	00 4764 210
Trombone 8'.....	01 8777 530
Trumpet 8'.....	00 6788 650
Tuba Sonora 8'.....	02 7788 640
Vox Humana 8'.....	00 4720 123

String family (bow pattern)

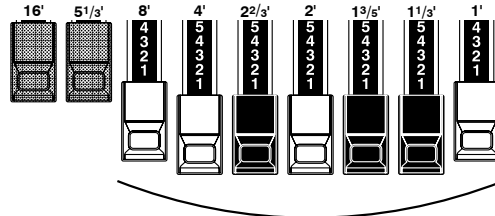

Cello 8'.....	00 3564 534
Dulciana 8'.....	00 7770 000
Gamba 8' I.....	00 3484 443
Gemshorn 8'.....	00 4741 321
Orchestral String 8'.....	00 1464 321
Salicional 8'.....	00 2453 321
Solo Viola 8'.....	00 2474 341
Solo Violin 8'.....	00 3654 324
Viola da Gamba 8'.....	00 2465 432
Violina 4'.....	00 0103 064
Violone 16'.....	26 3431 000

MODERN DRAWBAR REGISTRATIONS

The Drawbar registrations introduced on the previous page are typically for classical music.

They were created at the dawn of the Hammond Organ, when it was intended to sound like a pipe or church organ. Later on, as the Hammond Organ spread throughout Jazz, Pop, Rock and (especially) Gospel music, Some timeless registrations become common.

Jazz

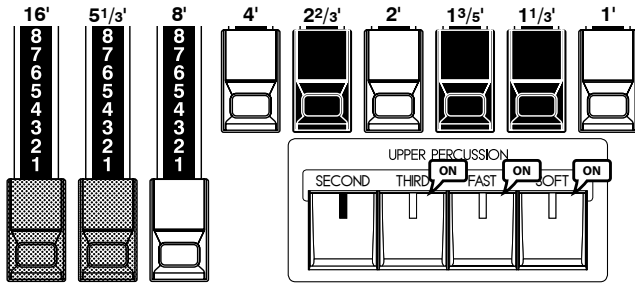

Bluesy

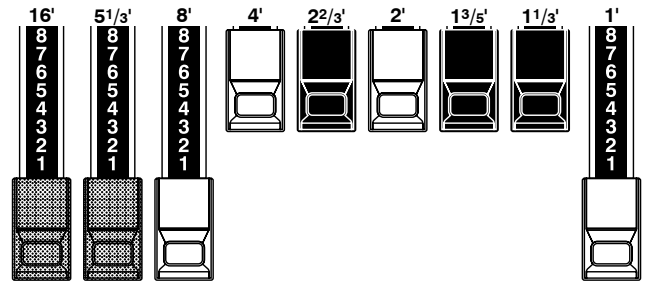

Groovy & Funky

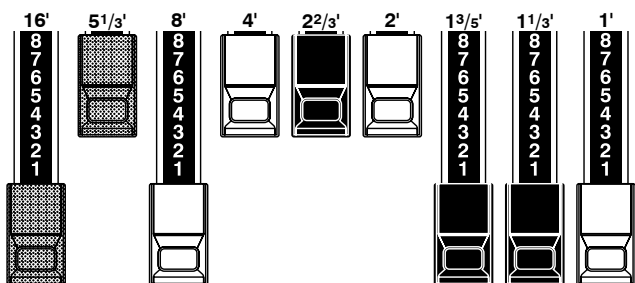

Max Power

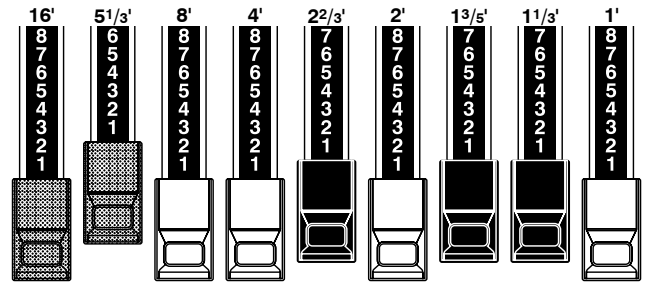

tips APPLICATION OF PERCUSSION

When Percussion is used, the sound of the 1' Drawbar is cancelled. As it was on the Vintage B-3. A trick is to keep the 1' drawbar fully out, and then turn the percussion on and off as you play for a instant change in sound. Try it!

DRAWBARS (Vx)

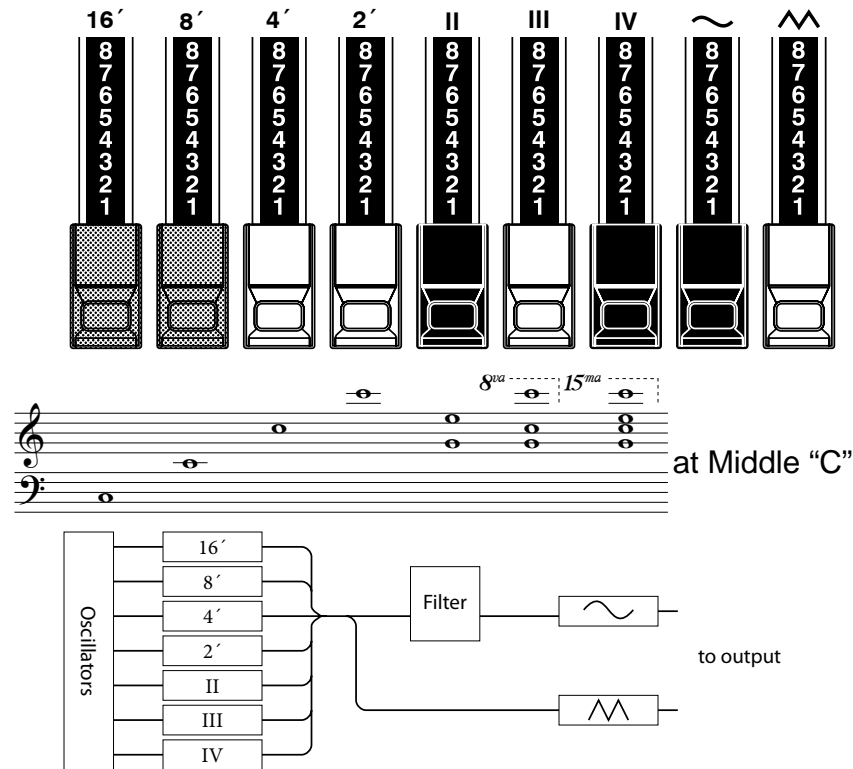

The original British Vx type organ was equipped with Drawbars, but the function was different from that of the Hammond Organ. The vintage arrangement has been re-created here.

Each of the 4 bars on the left functions similarly to the Hammond Organ. II, III and IV on the right are “Mixture” drawbars that sound plural pitches.

The 2 right-most bars are a mini mixer controlling the mellow voice or bright voice as in the vintage combo organ.

Each or both of the two right-most drawbars must be pulled in some combination to achieve sound in the Vx type.

tips FOOTAGE

The markings, “8’, 4” etc., indicate the lengths of pipes corresponding to their pitch. The common term for these numbers are “footages”.

For example, 8’ means that a pipe of 8’ in length sounds, the lowest C on a standard 5 octave organ keyboard.

Bass 16'	Strings 16'	Flute 8'	Oboe 8'	Trumpet 8'	Strings 8'	Flute 4'	Piccolo 4'	Strings 4'	Forf.
16'	8'	4'	2'	II	III	IV	~	^	Vx.
Bourdon	OpenDiap	Gedeckt	VoixClist	Octave	Flute Dolce	Flute	Mixture	Hautbois	Pipe
16'	8'	8'	II	4'	4'	2'	III	8'	

If the organ type is set to Vx, refer to the “Vx” row on the other side of the Drawbars for the correspondence between each bar and the footage.

DRAWBARDS (Farf)

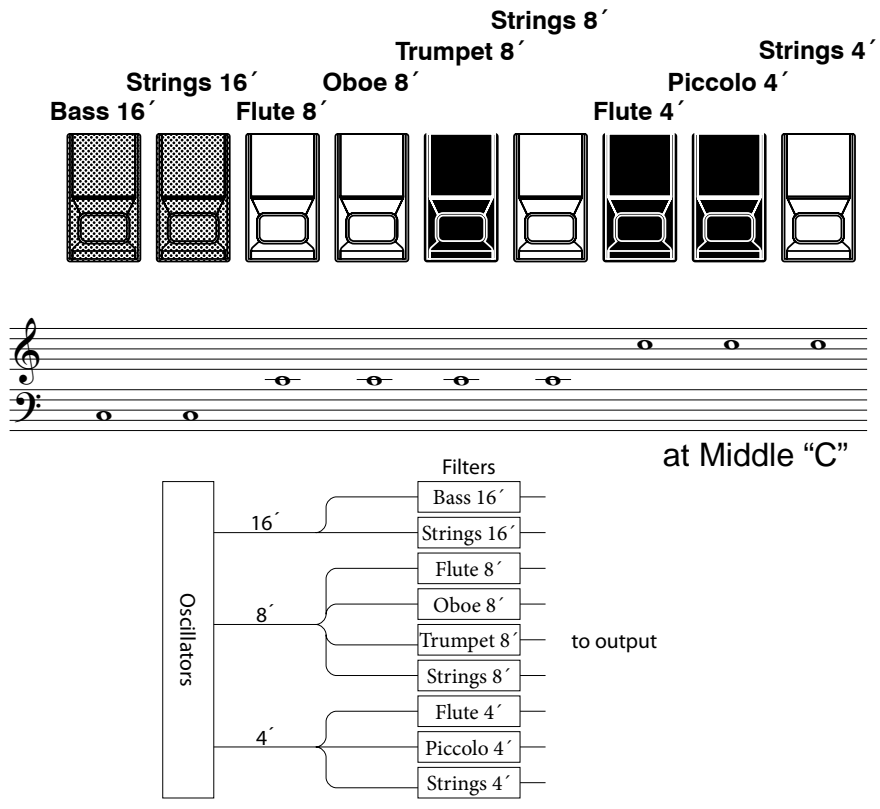

The original Italian Farf type organ was tablet-equipped with different sounds at various footages. On this keyboard the operation is made with Drawbars instead of tablets.

At the same footage, the tablets gives grow brighter in sound as you progress to the right. The names “Flute”, “Strings”, etc. are general descriptions and do not reflect the tonalities or characteristics of the real instruments.

Bass 16'	Strings 16'	Flute 8'	Oboe 8'	Trumpet 8'	Strings 8'	Flute 4'	Piccolo 4'	Strings 4'	Farf
16'	8'	4'	2'	II	III	IV	~	^	Vx.
Bourdon	OpenDiap	Gedeckt	VoixCist	Octave	Flute Dolce	Flute	Mixture	Hautbois	Pipe
16'	8'	8'	II	4'	4'	2'	III	8'	

When using the Farf type organ, refer to the “Farf” row on the other side of the Drawbars for the correspondence between each bar and the footage.

DRAWBARS (PIPE)

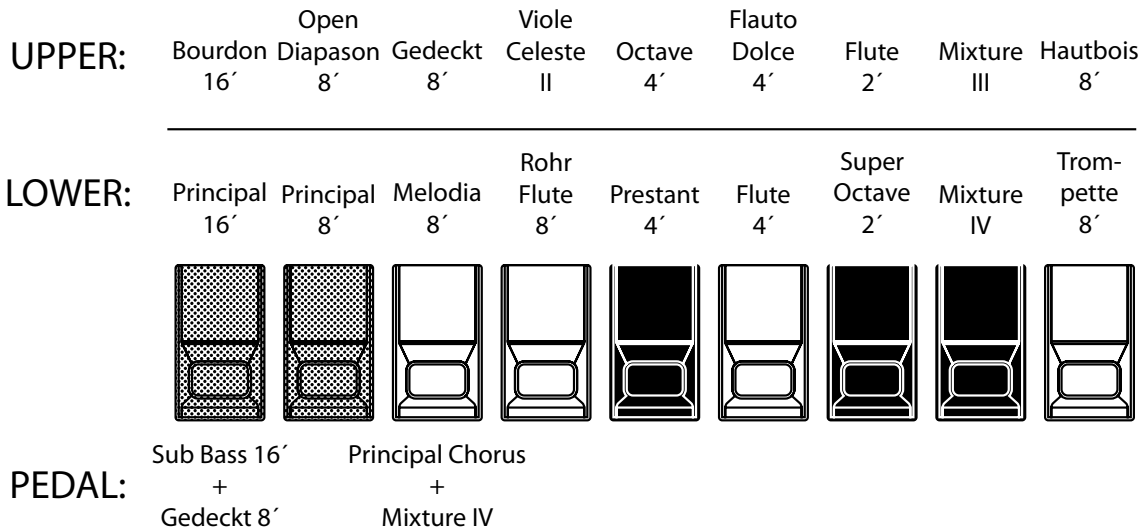

When using the PIPE organ type, the stops are registered through the Drawbars, and follow the classic organ layout left to right as follows: Flue, Mixture and Reed.

On the UPPER and LOWER parts, each Drawbar corresponds with a stop of the pipe organ.

On the PEDAL part, two stops sound with one Drawbar.

NOTE: The effects - Vibrato & Chorus, Leslie, Overdrive - are not available on the Pipe type voices.

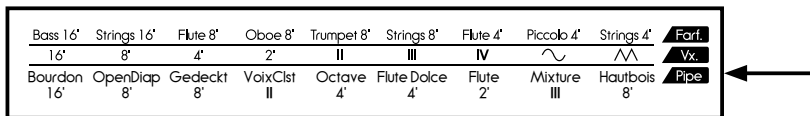

If the organ type is Pipe, refer to the "Pipe" row on the other side of the Drawbars for the correspondence between each bar and the footage.

ASSIGN DRAWBARS TO PARTS

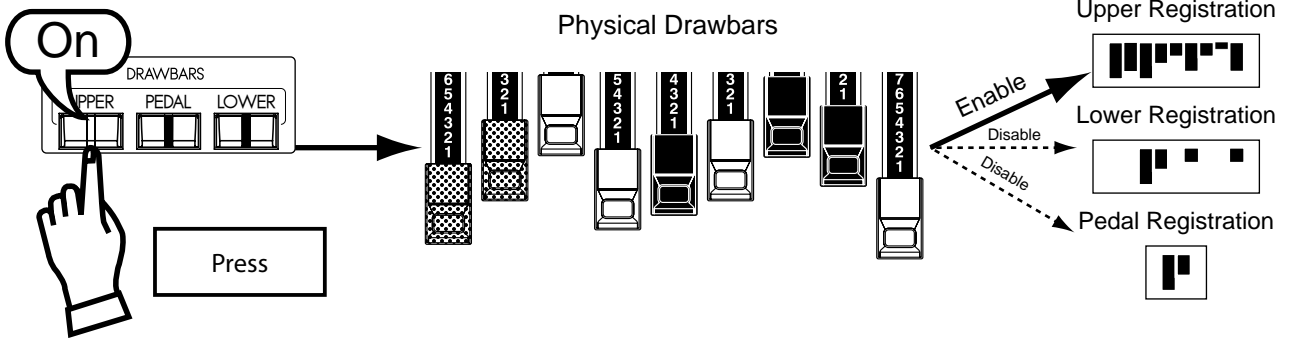

This keyboard has 3 parts; UPPER, LOWER and PEDAL. On the SK1, the keyboard is usually assigned to the UPPER, and, when you want to sound the LOWER, PEDAL, use the Split / Manual Bass Function or connect a MIDI keyboard and/or Pedalboard and assign each part.

Although there are three parts here, there is only one set of Drawbars. The [UPPER], [LOWER], and [PEDAL] buttons

allow you to register all the parts.

The Drawbars select buttons are [UPPER], [PEDAL] and [LOWER]. Which button you choose, sends the registration commands to proper part of the sound engine.

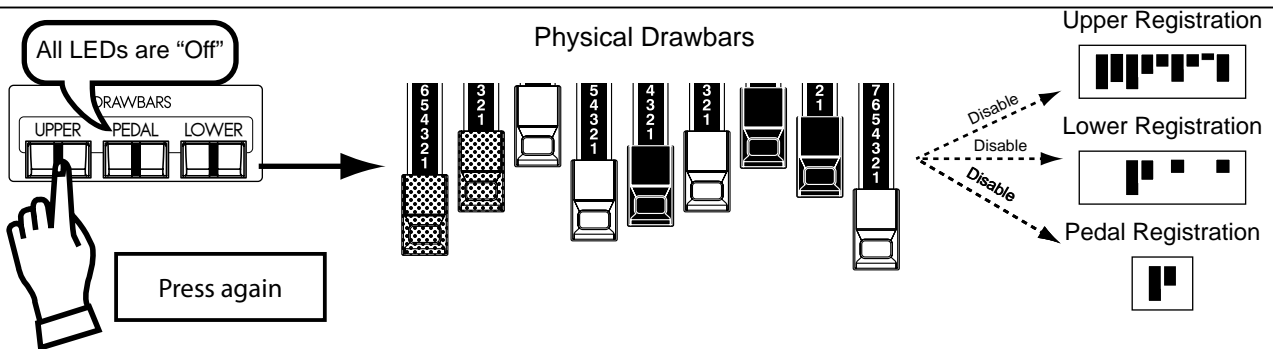

If you de-select any of the drawbar buttons, the instant control of the drawbars for that part is suspended. You can “pre-set” a registration, however (covered in next section)

MATCH THE REGISTRATION TO DRAWBARS

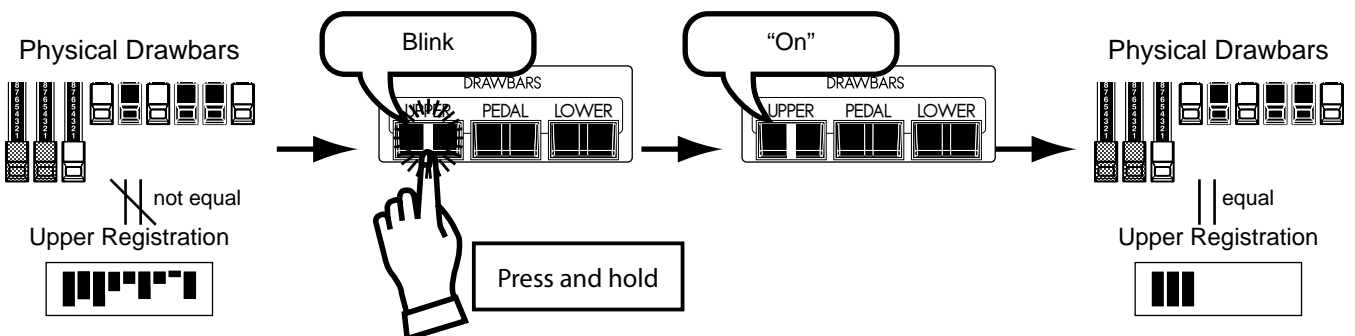

When you recall a patch, the Drawbar registration of the recorded patch is heard, instead of the physical Drawbar setting. If you move any Drawbar, its position takes precedence over the recorded registration, although the recorded preset is not altered.

If you wish to switch to the physical Drawbar setting, Press

and hold the corresponding button ([UPPER], [PEDAL] or [LOWER]) in the Drawbar select until the light blinks then release it. The physical registration now becomes “current”.

PERCUSSION

Organ tones are normally heard as long as the playing key is held down. The word “Percussion” refers to a tone that is not steady and fades away, such as a piano or chimes. This keyboard has Percussion tones which enhance the sounds produced by the Drawbars.

“Touch-Response Percussion” is very useful for highlighting single notes, full chords, even entire songs.

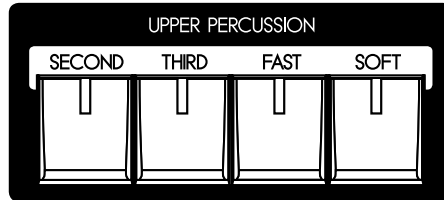

[SECOND] button

The 2nd harmonic speaks at the same pitch as the 4' Drawbar. Combining this 2nd harmonic with the Drawbars will produce a bright and clear attack.

To engage, press the [SECOND] button and the light will go ON.

[THIRD] button

The 3rd harmonic tone speaks at the same pitch as the 2 $\frac{2}{3}$ ' Drawbar. Combining this 3rd harmonic with the Drawbars will produce the ringing attack that has become a Hallmark Hammond sound.

To engage, press the [THIRD] button and light will go ON.

[FAST] button

When this button is OFF (LED not lit) the percussion tone will decay (decrease in volume) slowly like a chime. When [FAST] is “ON” (LED is lit) the percussion tone will decay rapidly like a xylophone.

tips DECAY

On the piano, the sound gradually fades out even if you keep touching the key. It is called Decay. The violin sound, on the contrary, keeps sounding at a certain volume. It is called Sustain.

[SOFT] button

This control regulates the volume of the percussion tone. When it is OFF (LED not lit) the percussion effect will be very prominent, compared to the tones produced by the UPPER Drawbars.

NOTE: Percussion is available on 3 Organ types; BType1, BType2 and Mellow.

NOTE: You can fine-tune the parameters of the Percussion (P. 82).

1' DRAWBAR CANCEL

As on the Vintage Hammond B-3, the 1' Tone-Wheel Drawbar is inoperative when the Percussion is engaged.

NOTE: If you wish the 1' Drawbar to remain operative, you can change the parameter. (P. 82)

The Hammond Vibrato & Chorus is another hallmark of the Classic Hammond sound. Vibrato alters the pitch slightly, as a violinist, singer, or guitarist may do. And Chorus combines a detuned signal with the original for a lush tone.

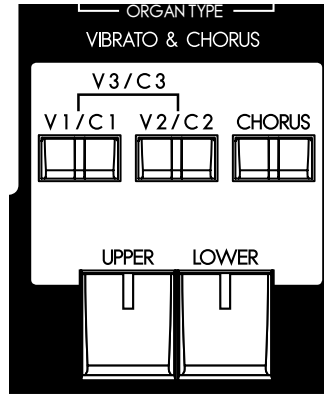

[UPPER] button

Pressing [UPPER] button “ON” (red LED lit) will turn the Vibrato & Chorus effect on for the UPPER Drawbars.

[LOWER] button

Pressing [UPPER] button “ON” (red LED lit) will turn the Vibrato & Chorus effect on for the LOWER Drawbars.

[V1/C1], [V2/C2] button

These buttons are for setting the depth of the Vibrato & Chorus effects.

- V1 (C1):** V1 (C1), light vibrato (chorus)
- V2 (C2):** V2 (C2), vibrato (chorus) of standard depth.
- V1+V2 (C1+C2):** V3 (C3), deepest vibrato (chorus)

NOTE: While the power is on, the Vibrato and/or Chorus button LED’s will always be on. The effect will not be active unless the UPPER or LOWER switches are pressed (LED on).

[CHORUS] button

The CHORUS effect combines a slightly detuned signal with the original. To engage the Chorus effect, press this button and the light will go ON.

NOTE: Vibrato & Chorus is available on 5 Organ types; BType1, BType2, Mellow, Vx and Farf.

NOTE: The speed etc. of the Vibrato & Chorus effects can be fine-tuned. (P. 83)

NOTE: The Vibrato & Chorus effects on this keyboard come from a virtual model of the mechanical scanner as first used on the vintage B-3. It operates in the same manner, albeit in the digital realm. (no moving parts)

tips

STATUS CHART OF EACH BUTTON

BUTTON			MODE
V1/C1	V2/C2	CHORUS	Effect
On	Off	Off	V1
Off	On	Off	V2
On	On	Off	V3
On	Off	On	C1
Off	On	On	C2
On	On	On	C3

DRAWBAR OVERDRIVE

Overdrive simulates the effect of pushing an amplifier beyond its normal limits to achieve a more aggressive sound.

By changing the drive amount, various sounds are obtained from an unclipped warmth to a hard distortion.

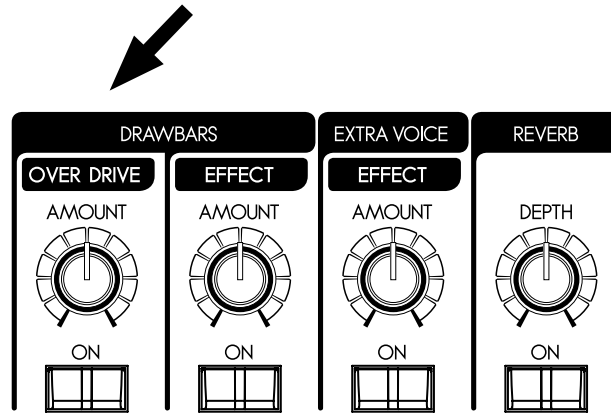

[OVERDRIVE ON] button

To engage the Overdrive effect, press this button and the light will go ON.

[OVERDRIVE AMOUNT] knob

Adjusts the amount of the Overdrive effect.

Rotating the knob clockwise increases the depth of the effect.

NOTE: Drawbar Overdrive is available on 5 Organ types; BType1, BType2, Mellow, Vx and Farf.

NOTE: You can fine-tune the overdrive sound. (P. 92)

NOTE: The button and knob are for the Organ section. The Overdrive effect for the Extra Voice section is operated by the parameter in the control panel. (P. 99)

The rotating sound of the LESLIE Speaker is the natural partner of the Hammond Organ. A Digital version is built-in to the SK1/SK2; and the controls will also function with a connected physical Leslie.

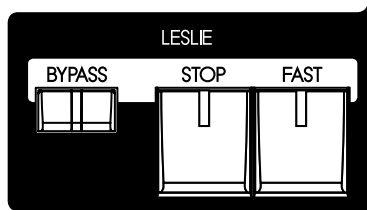

[FAST] button

Toggles the mode of the rotor by two steps. Every press switches the status. When the light is ON, the mode is FAST, and when it is OFF, it is not.

[STOP] button

To toggle the FAST and SLOW when you pressed the [FAST] button, press this button and the light OFF.

To toggle the FAST and STOP when you pressed the [FAST] button, press this button and the light ON.

[BYPASS] button

When the light is OFF, the Organ section sound is output from the rotary channel.

To bypass the Leslie effect, press this button and the light will go ON. Regardless of the status of the [FAST], [STOP] buttons, the Organ section sound is output from the stationary channel.

NOTE: Leslie Effect is available on Organ section except Pipe type.

NOTE: You can fine-tune the parameters of the Leslie effect. (P. 84)

tips STATUS CHART OF EACH BUTTON

BUTTON			MODE	
BYPASS	STOP	FAST	CH=1	CH=3, on-board Leslie effect
Off	Off	On		Fast
Off	Off	Off		Slow
Off	On	On		Fast
Off	On	Off		Stop
On	On	On	Fast	Bypass
On	On	Off	Stop	
On	Off	On	Fast	
On	Off	Off	Slow	

Diagram of 3 channel Leslie Speaker

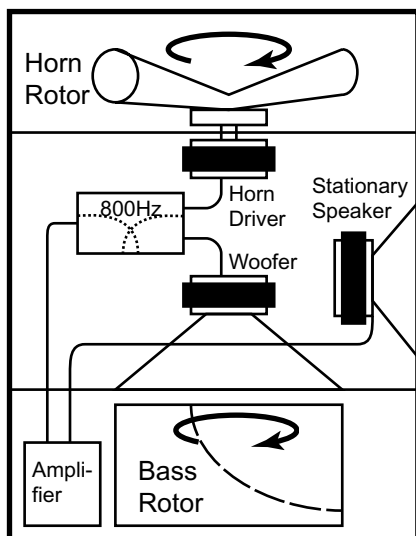

tips WHAT IS THE LESLIE EFFECT?

The Leslie Speaker was invented by Donald Leslie in 1941 to make the Hammond Organ sound like a Theatre Pipe Organ. Using motor-driven rotating horns and baffles, Leslie's invention gave the organ a rich and moving tone, which quickly became it's own unforgettable sound.

In its basic form, the Leslie Speaker has an built-in amplifier and two rotors; the "Horn Rotor" for treble and the "Bass Rotor" for bass which are each fed by a custom-designed driver/speaker. The combination of the two utilizes the "Doppler Effect" to give the unique Leslie "swirling" sound..

Some models have not only rotors but also a fixed speaker. The circuit for sending the sound to the rotor is called the "Rotary Channel", and that for the fixed speaker is called the "Stationary Channel".

The Digital Leslie on-board the SK1/SK2 employs all the proprietary concepts used in the physical speakers, but realizes them in the digital realm. It is recommended that you run the Main Outputs "in stereo" to get the fullest effect.

MULTI-EFFECTS, REVERB

The SK1/SK2 has on-board Digital Multi-Effects and Reverb to enhance the Organ section.

◆MULTI-EFFECTS

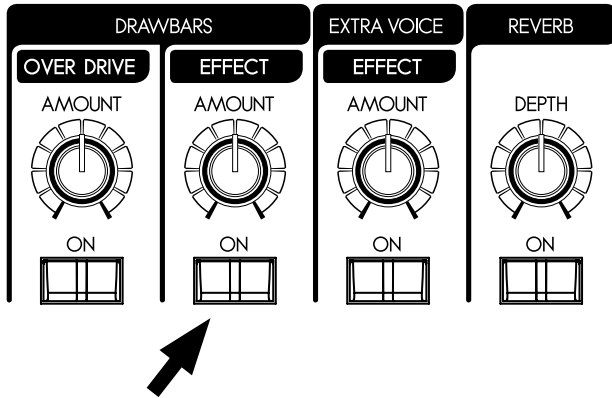

[EFFECT ON] button

To engage the Multi-Effects. Press this button and the light will go ON.

[EFFECT AMOUNT] knob

Adjusts the amount of the Multi-Effects.

NOTE: There are numerous parameters in the Multi-Effects. The detailed settings of the parameters are adjusted on the control panel. (P. 92)

◆REVERB

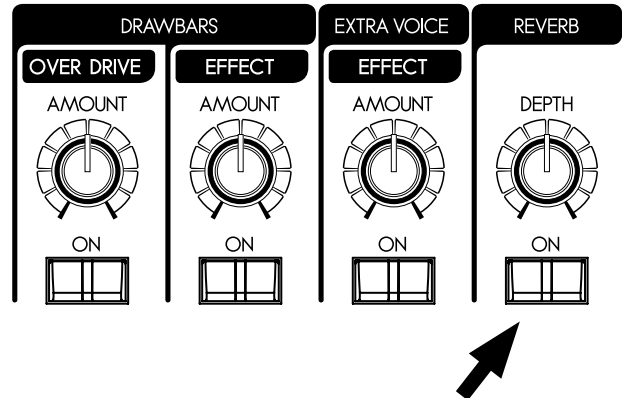

The Digital Reverb is common to both Organ and Extra Voice sections.

[REVERB ON] button

To engage the Reverb, press this button and the light will go ON.

[REVERB DEPTH] knob

Adjusts the depth of the Reverb.

NOTE: You can fine-tune the time etc. of the Reverb. (P.101)

A popular option for playing the Pedals or Manual Bass is Pedal Sustain, which allows the Pedal voice to smoothly decay upon release, much in the manner of a string bass. Using the lowest note of the keyboard, you can play the PEDAL part together (Manual Bass).

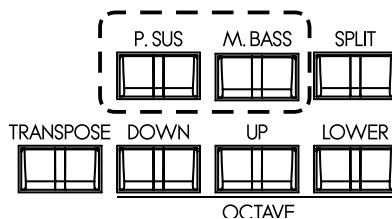

[P. SUS] button

To engage the PEDAL SUSTAIN, press the [P. SUS] button and the light will go ON. After releasing your foot from the Pedal keyboard (or, if you release your finger from the Manual keyboard when you are using the Manual Bass function) (= explained later in this manual), the sound will slowly fade, or decay.

NOTE: You can control the decay time of the Pedal Sustain. (P. 75)

[M. BASS] button

To engage the Manual Bass function, press the [M. BASS] button and the light will go ON.

The keyboard that functions as the Manual Bass is the keyboard itself if it is on the SK1 stand-alone, and the Lower keyboard if the Lower keyboard is added to the SK1 or SK2. The default range of the MANUAL BASS is up to the middle “B”.

NOTE: You can change the highest note range of the MANUAL BASS (P. 112 #2).

NOTE: You can select the MANUAL BASS play chords or only the lowest note (P. 112 #1).

tips COUPLER

Like the Manual Bass or the Lower to Pedal (only on the SK2), the function to set a keyboard to play two keyboards together is called “COUPLER”.

KEYBOARD SPLIT, OCTAVE SHIFT

The SK1 normal range is the UPPER Keyboard. A split is optional to place the LOWER keyboard voices on the left side of the single keyboard.

The keyboard can be shifted up or down one octave to facilitate easier play.

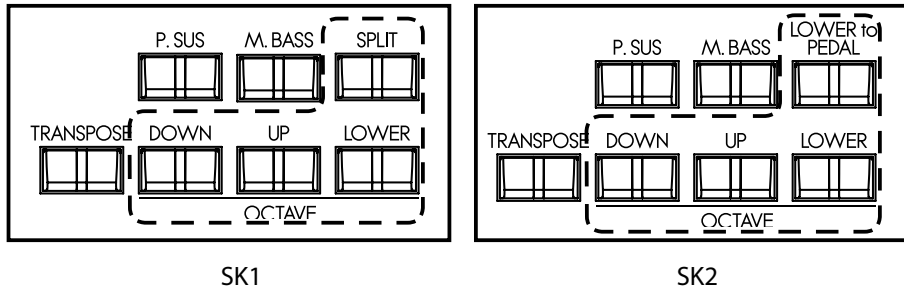

SK1

SK2

[SPLIT] button (only on the SK1)

Press to split the keyboard, and the light will go ON.

NOTE: You can set the split point. (P. 112)

[OCTAVE] buttons

Raises or Lowers each part by one octave.

- ◆ To raise UPPER by one octave, press the [UP] button.
- ◆ To lower UPPER by one octave, press the [DOWN] button.
- ◆ To raise LOWER by one octave, press the [UP] button, holding down the [LOWER] button.
- ◆ To lower LOWER by one octave, press the [DOWN] button, holding down the [LOWER] button.

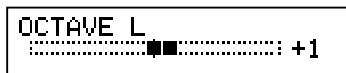

Octave of LOWER is at "+1".

When changing octaves here, the status of the Octave is briefly shown on the display.

[LOWER to PEDAL] button (only on the SK2)

Allows whatever sounds that are registered on the LOWER Part to be played on the PEDAL part as well. To use this function, press this button and turn the light ON.

NOTE: You can change the upper limit playing range of 'Lower to Pedal'. (P. 112)

The transpose function allows you to match the same key of other instruments or vocalists without changing the key that you are playing in.

For example, if you set Transpose at [+5], the note “F” sounds when you play the “C” key. (By playing in the key of C the SK1 sounds in the key of F.)

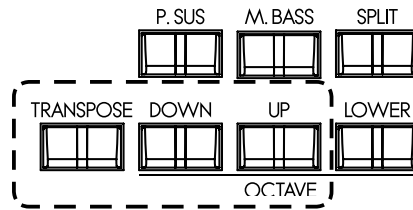

[TRANSPOSE] button

- ◆ To raise the pitch by semi-tone, press the [UP] button, while holding down the [TRANSPOSE] button.
- ◆ To lower the pitch by semi-tone, press the [DOWN] button, while holding down the [TRANSPOSE] button.

You can set Transpose in the range from -6 to +6 semi-tone.

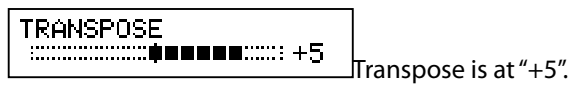

When performing this operation, the status of the transposition is shown in the display.

Transpose is mapped to the following points:

- Between the internal keyboard and the built-in sound engines.
- Between the MIDI IN and the built-in sound engines.
- To the external zone.
- When the MIDI pedalboard XPK-100 is connected, transpose value will synchronize with it.

NOTE: Transpose is a temporary parameter, and is not recorded to any patch. When the power is switched OFF, it returns to 0.

EXTRA VOICE SECTION

The EXTRA VOICE section contains the sounds other than Organ which comprise the SK series. As a single system, you select which voice to allocate to what part.

The Organ and Extra Voice sections can be played simultaneously.

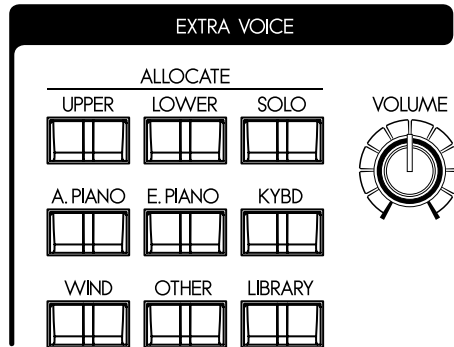

ALLOCATE AND SOLO

To play the Extra Voices, you must allocate them to either the UPPER or LOWER parts. The Extra Voices can play alongside the Organ and can also be soloed, muting the organ section.

[ALLOCATE UPPER], [ALLOCATE LOWER] buttons

Selects either the UPPER/LOWER part to allocate Extra Voices. To play the Extra Voices, press either button and (LED ON).

To CANCEL the Extra Voice allocation, press the desired button again (LED OFF).

[SOLO] button

Mutes the Organ section to play only the Extra Voices.

The solo functions toggled ON and OFF by pressing [SOLO] button.

tips EXTRA VOICE

The Extra Voice section on your SK1/2 is not related to, and does not replicate the sounds of F-100 "Extravoice" (1960's).

BUILT IN SOUNDS AND LIBRARY

There are 6 groups of resident sounds, corresponding to the Voice Group. These core sounds may not be overwritten. You may expand this core with sounds available online from "LIBRARY", which Hammond-Suzuki will make available in the future.

To select instruments, see "SELECT INSTRUMENTS" on (P. 31), and the "INSTRUMENT LIST" (P. 136) for the built in sounds.

tips PRO-CHORD FUNCTION

In the Extra Voice instruments, some are set with the "Prochord" function. These are for easily playing on the keyboard the harmony heard from the brass section etc.

The instrument with a Prochord has "Pcd" as a suffix added to its name.

If you allocate this instrument to the Upper part, play a chord on the Lower keyboard and play a single note on the Upper keyboard, you can get a melody with harmony.

ON SK1:



ON SK2:

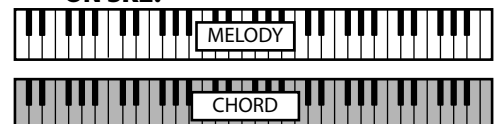

This keyboard is equipped with Multi-Effects capable of adding various effects to the Extra Voices, and Reverb capable of adding the effects of playing in a concert hall.

◆MULTI-EFFECTS

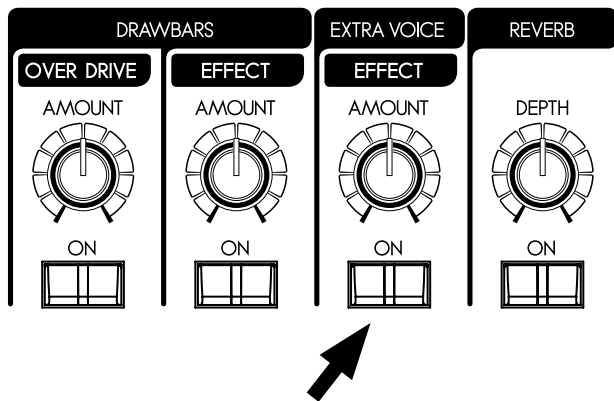

[EFFECT ON] button

To engage the Multi-Effects, press this button and the light will go ON.

[EFFECT AMOUNT] knob

Adjusts the amount of the Multi-Effects.

NOTE: There are numerous parameters in the Multi-Effects. Detailed settings are made with the parameters in the control panel. (P. 99)

◆REVERB

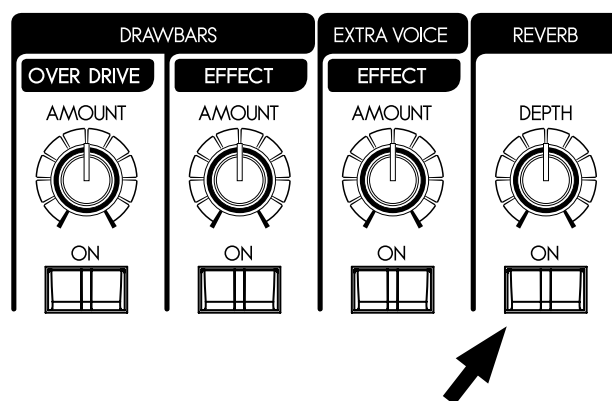

Reverb is common for both the organ and the Extra Voice sections.

[REVERB ON] button

To engage the Reverb, press this button and the light will go ON.

[REVERB DEPTH] knob

Adjusts the depth of the Reverb.

NOTE: You can fine-tune the time etc. of the Reverb effect. (P. 101)

The settings you have prepared can be recorded to User Patches.

USER AND PRESET

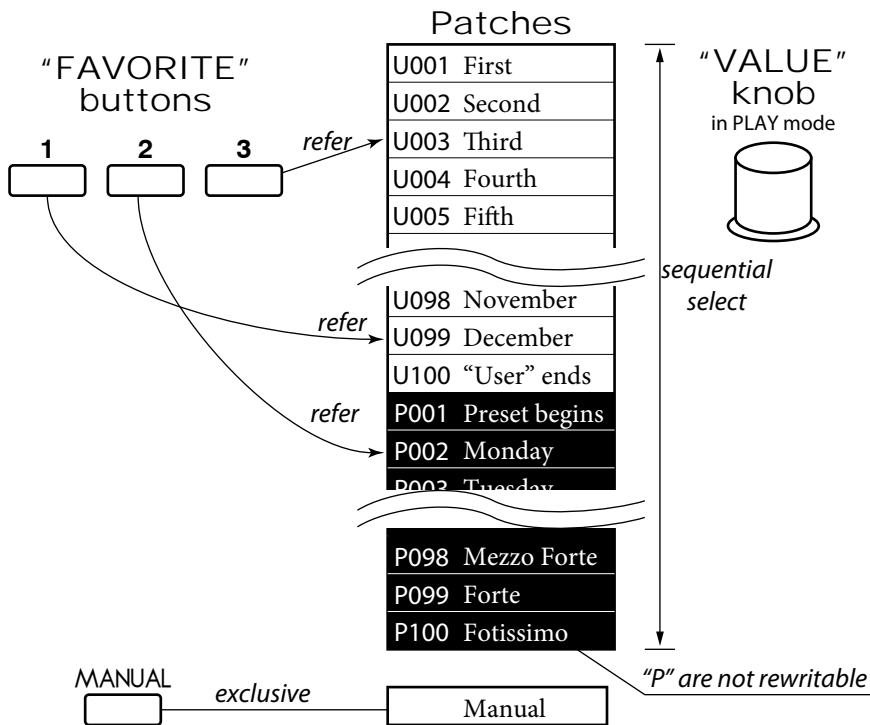

The [MANUAL] button on the left side of the top panel shifts the focus to all the current settings of the top panel, and the current internal settings. It is used as a starting point for writing your own patches, or for the musician who prefers to register "by hand" instead of using patches.

There are 100 USER and 100 PRESET Patches as illustrated. The "User" Patches are over-write capable. The "Preset" Patches are not.

To call the Patch, select the Patch Number with the [VALUE] knob in the Play mode (P. 23).

To record the present setting to the patch, first give a name to it and designate the patch number before recording the patch (next page).

tips PATCH LOAD

Only the Drawbar registrations of each keyboard were recorded to the preset of the B-3/C-3. But many more parameters than the Drawbar registrations are recorded to the patches on this keyboard. If you wish to keep the "traditional" style of registration (Drawbars only), Select the proper parameters in "Patch Load". (P. 76)

NAME THE PRESENT SETTING

1 GO TO THE MENU MODE

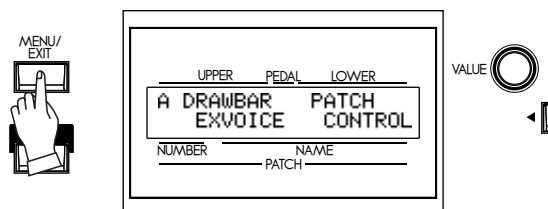

Press the [MENU/EXIT] button.
Menu mode will be displayed.

2 GO TO PAGE A

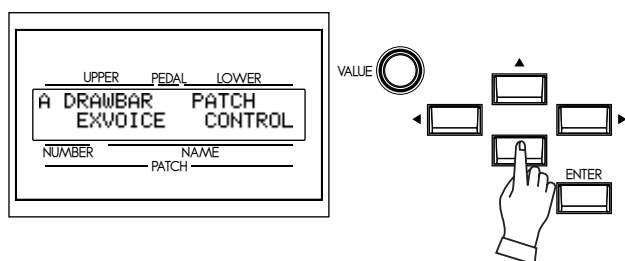

If Page A is not displayed, go to Page A by pressing [▼] button.

2 SELECT THE "PATCH"

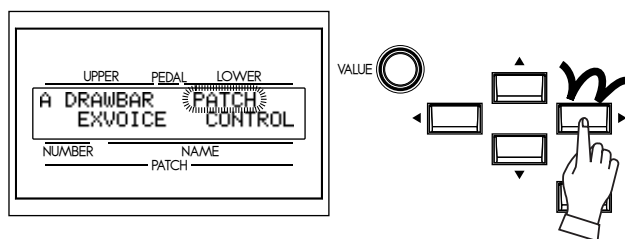

Press [▶] button twice and move the cursor to "PATCH".

3 GO TO PATCH FUNCTION MODE

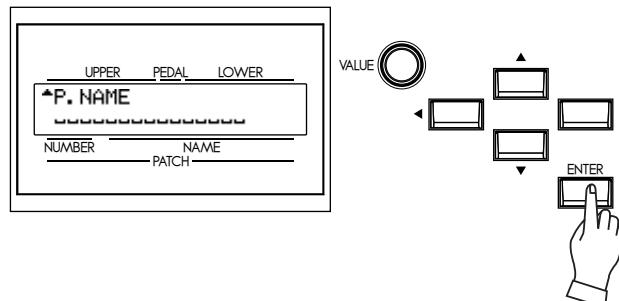

Press [ENTER] and go to PATCH function mode.

4 INPUT NAME

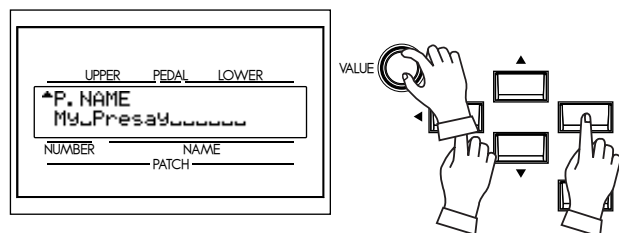

You can enter a name using up to 15 letters.

[◀],[▶] buttons: Moves the cursor.

[VALUE] knob: Selects letters.

The Characters available are the Capital and small English Alphabet, signs and digits.

The name input here is not captured until you record the patch (as explained on the next page).

RECORD TO THE PATCH

Example: RECORD TO "U032"

1 GIVE THE NAME



Enter the name of your Patch. (P. 61)

2 PRESS THE [RECORD] BUTTON

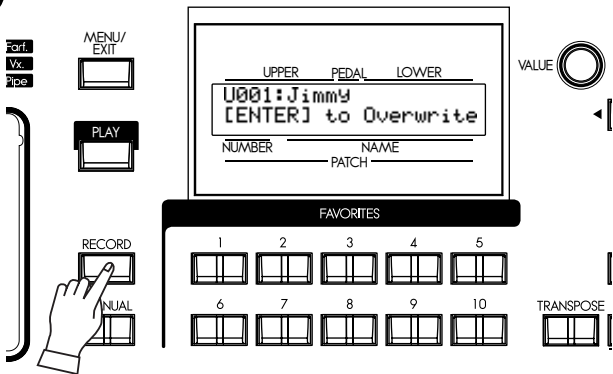

Press the [RECORD] button. The Record mode is displayed.

3 SELECT THE PATCH NUMBER

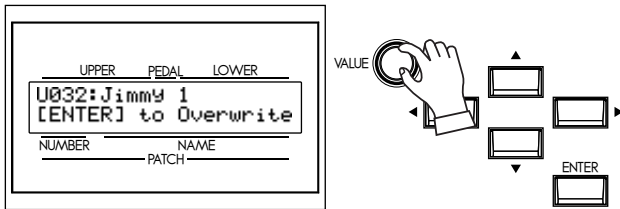

Select the patch number you wish to record with the [VALUE] knob (This time select U032).

4 PRESS [ENTER]

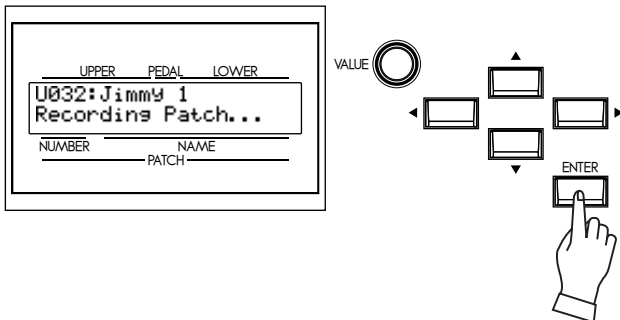

Press the [ENTER] button. The patch is confirmed and is displayed as follows for a few seconds:

Recording Patch...

When the recording is completed, the display returns to the previous one.

NOTE: The recorded patch data is retained if the power is switched off or disconnected.





**USING THE
CONTROL PANEL**

WHAT YOU CAN DO ON THE CONTROL PANEL

Your access to deep-editing the SK1/SK2. All of the parameters and all of the controls not covered by the top panel knobs and switches are here.

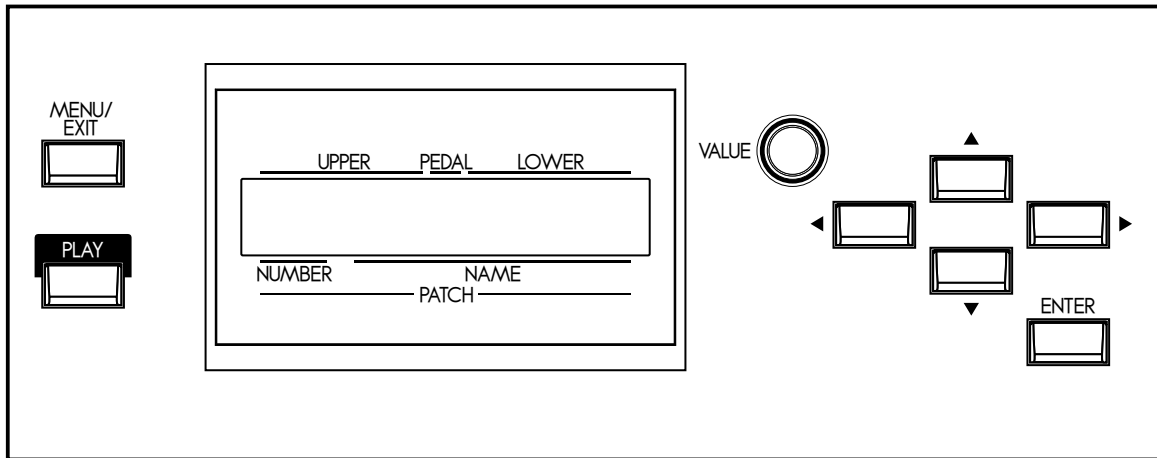

The modes displayed are, basically “PLAY”, “MENU” and “FUNCTION”. See how to read them and how to use the buttons on the next pages.

PLAY mode

```

███ 88 ███
U064 Or:Born To Be W
  
```

MENU mode

```

A DRAWBAR PATCH
EXVOICE CONTROL
  
```

FUNCTION mode

```

♣BASS SLOW FAST LEV
SPD 36 393 0▶
  
```

The Play mode is basic for all operations. All information necessary for ordinary performance is displayed here.

To locate this mode

1. "Play mode" is the default mode at power-up.
2. If the Play mode is not displayed, touch the [PLAY] button.

HOW TO READ THE DISPLAY

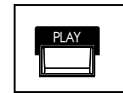
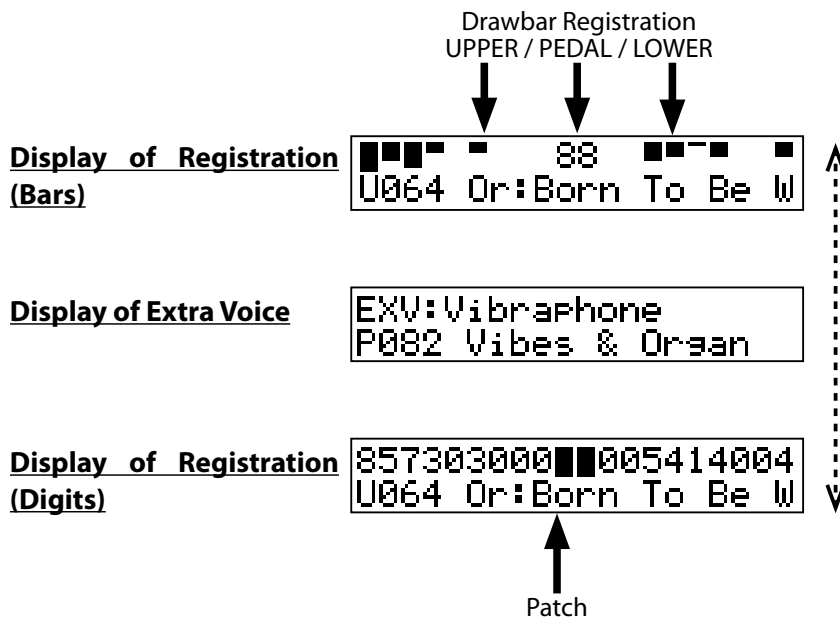

The three PLAY modes, two for displaying the Registration and the other for displaying the Extra Voices, are toggled every time the [PLAY] button is pressed.

BUTTON OPERATION IN THIS MODE

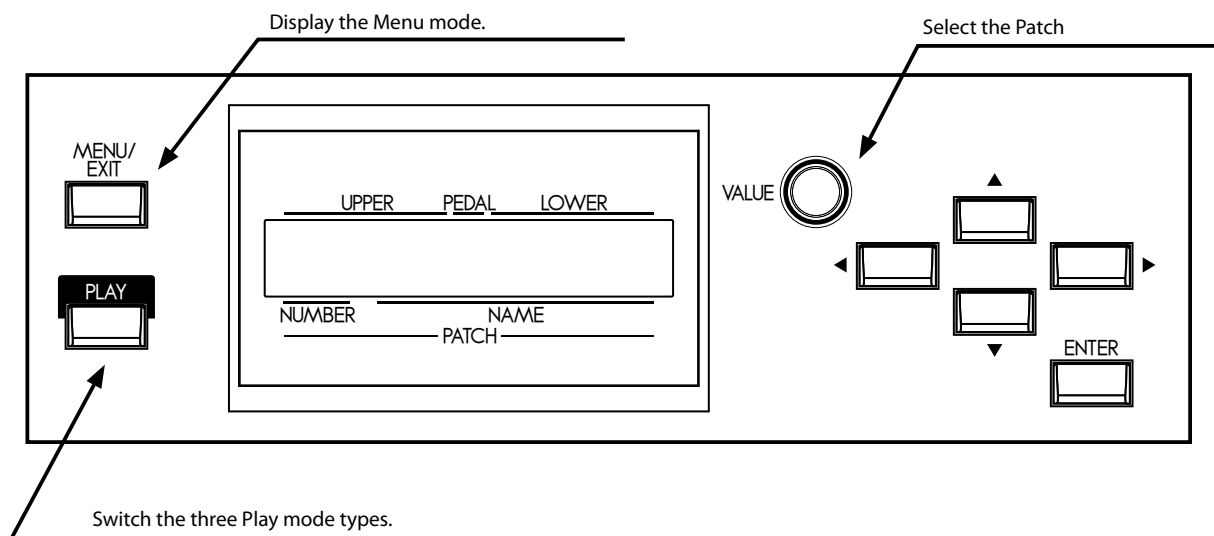

MENU MODE

The purpose of the menu mode is to give a directory of all the various function.

To locate this mode:

Press the [MENU/EXIT] button.

There are many pages functions available to edit. For easier editing, the different divisions in the menus are grouped together in bundles of four. Search for the item you wish to edit using the direction buttons, then press the [ENTER] button and display each Function mode.

HOW TO READ THE DISPLAY

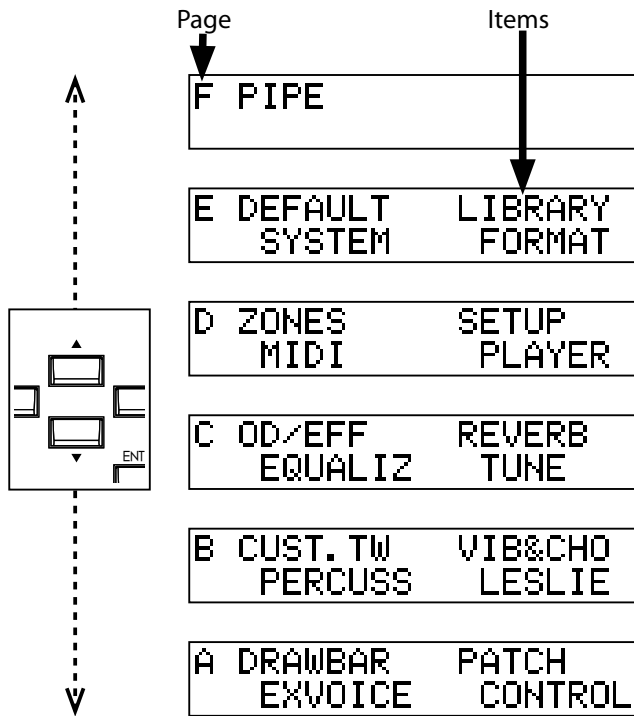

BUTTON OPERATION IN THIS MODE

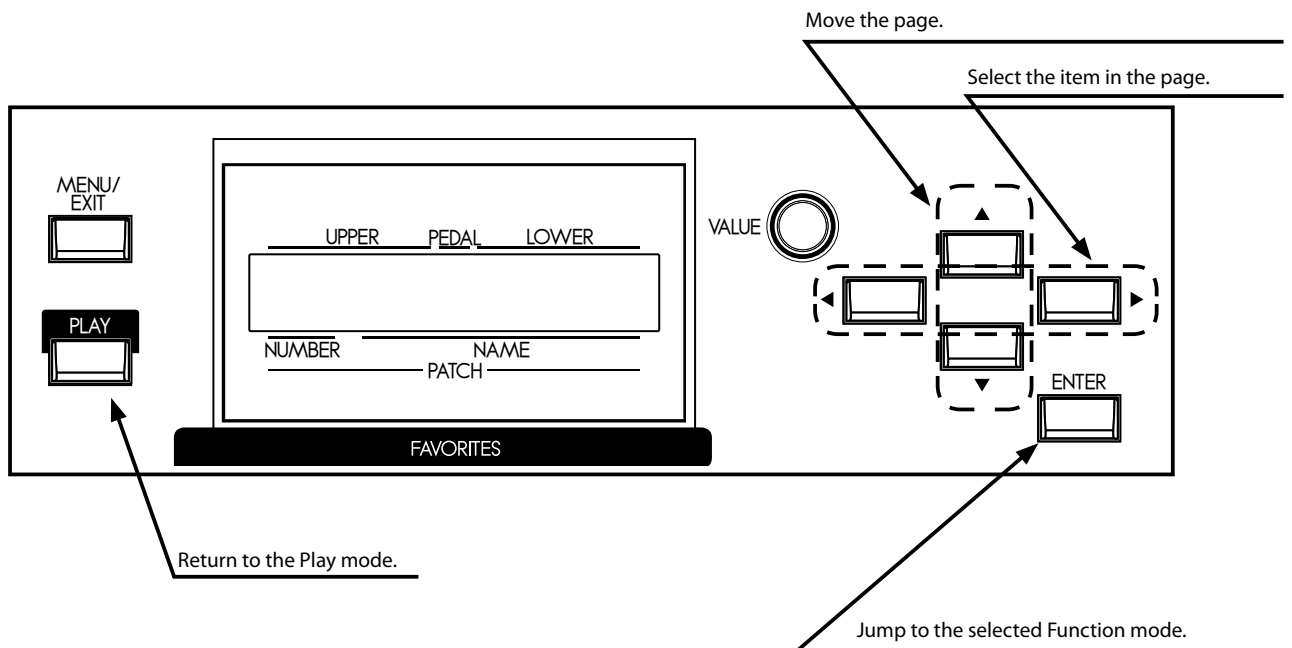

MENU AND THE CONTENTS

PAGE A

1. DRAWBAR

Sets the parameters for each of the Organ section's Drawbars. (P. 74)

2. EXVOICE

Selects the Extra Voice instrument, plus, its range and volume. (P. 77)

3. PATCH

For naming the patch, setting which parameters will load and assignment of Favorites. (P. 76)

4. CONTROL

For setting the controllers, such as the Expression Pedal and Foot Switch. (P. 78)

PAGE B

1. CUST.TW

For custom setting of the tone wheel sets of the Lower and Upper part. (P. 78)

2. PERCUSS

For custom setting the percussion parameters. (P. 82)

3. VIB & CHO

For custom setting the speed and depth of the Vibrato & Chorus. (P. 83)

4. LESLIE

For adjusting the built-in Leslie effect and sets the external Leslie speaker. (P. 84)

PAGE C

1. O.D./EFF

Adjust the Overdrive and the Multi-Effects here. (P. 92)

2. EQUALIZ

For setting the parameters of the Equalizer. (P. 100)

3. REVERB

For setting the parameters of the Reverb. (P. 101)

4. TUNE

Set the tuning of the entire keyboard. (P. 102)

PAGE D

1. ZONE

For setting the Internal Zone/External Zone. (P. 112)

2. MIDI

For setting the basic MIDI operations. (P. 114)

3. SET-UP

For saving/loading the set-up to/from the USB Flash Drive. (P. 118)

4. PLAYER

For operating the Music Player. (P. 127)

PAGE E

1. DEFAULT

For returning to the factory default setting. (P. 103)

2. SYSTEM

For setting the System Parameter(s) and displaying the information. (P. 104)

3. LIBRARY

For controlling the Sound Library of the Extra Voices. (P. 131)

4. FORMAT

For initializing the USB Flash Drive. (P. 119)

PAGE F

1. PIPE

For custom setting of the Pipes. (P. 90)

FUNCTION MODE

These modes are for selecting and controlling the function.
All modes can be navigated the same way.

HOW TO READ THE DISPLAY

There is another page above (or below) this page.

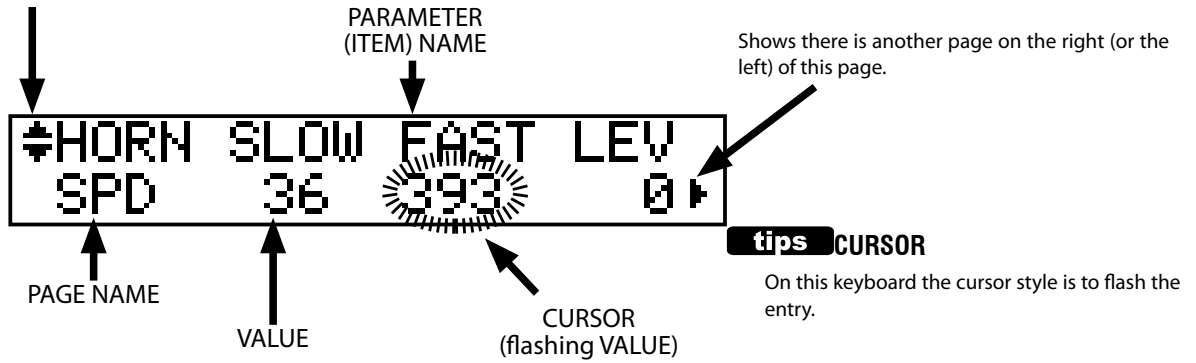

BUTTON OPERATION IN THIS MODE

Move the page up or down.

Move the cursor on the page. The cursor goes to the edge of the mode, and, if there is another page on the right or the left, moves to that page.

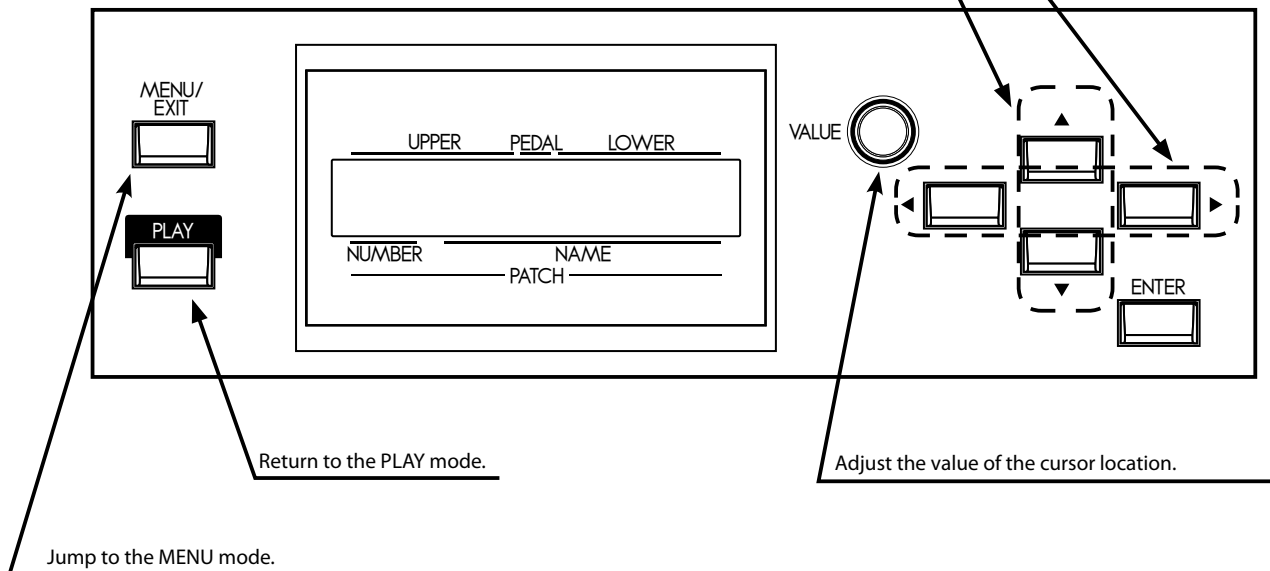

Each button on the top panel has a built in shortcut-making programming and editing easier.

Pressing and holding any of the buttons on the top panel automatically jumps the display to the related function menu item.

EXAMPLE OF OPERATION:

LOCATE THE PERCUSSION FUNCTION MODE

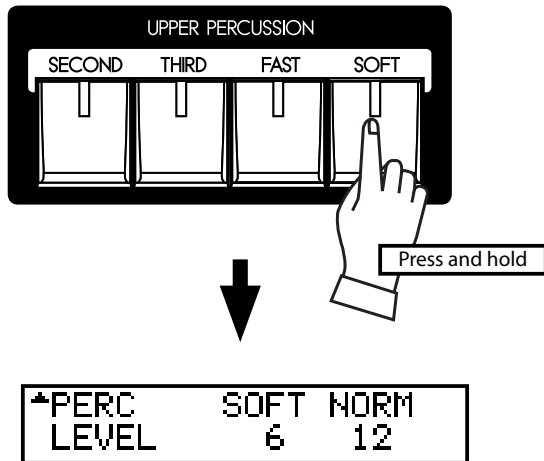

If you wish to edit the percussion settings, press and hold either of the [SECOND], [THIRD], [FAST], or [SOFT] buttons, and the display will immediately jump to the percussion function mode. This is called “SHORT CUT”.

In the next chapter, you will see which button is used for a particular “SHORT CUT”.

NOTE: Changing the length of time until display jump when button held. (P. 81)

REGISTER THE PAGES YOU FREQUENTLY USE

You can assign frequently-used function page to the [CONTROL] button for immediate access.

EXAMPLE OF OPERATION:

REGISTER THE “DRAWBAR - PEDAL” PAGE

1



Display the page you want to register using the MENU etc. Here, as an example, let's display the “Drawbar - Pedal” page.

2

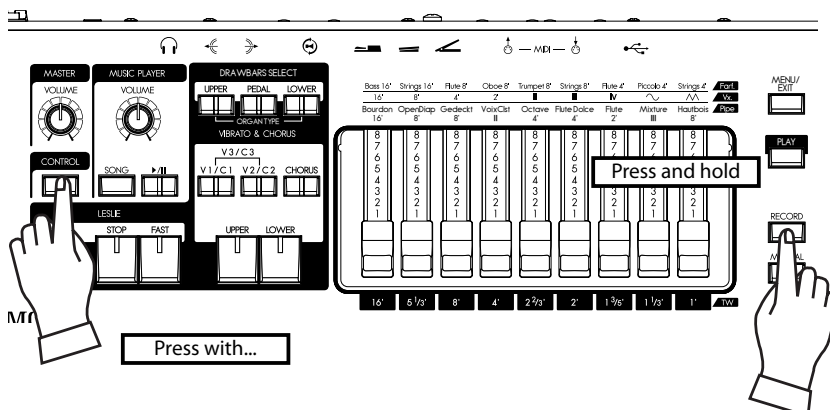

While holding down the [RECORD] button press the [CONTROL] button. You will be able to immediately access the desired page just by pressing the [CONTROL] button.

PARAMETER OPERATION EXAMPLE:

ADJUST THE [FAST] PERCUSSION DECAY TIME

1 LOCATE THE MENU MODE

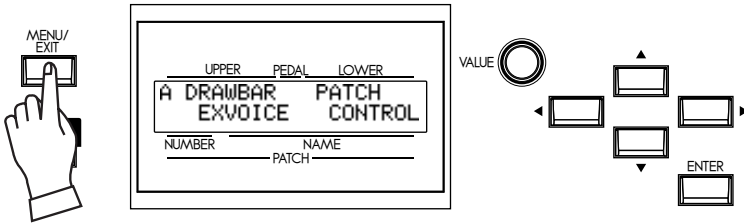

Press the [MENU/EXIT] button.
The MENU mode is displayed.

2 SELECT THE MENU PAGE

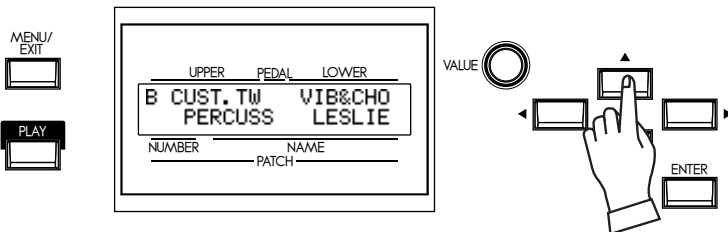

Locate the "PERCUSS" page using the [▲],[▼] buttons.
"PERCUSS" is on Page B.

3 MOVE THE CURSOR TO THE FUNCTION MODE YOU WISH TO LOCATE

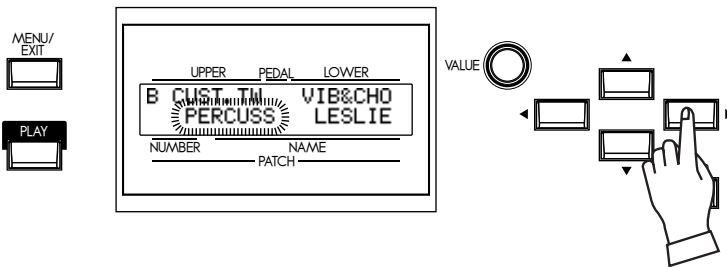

Move the cursor to "PERCUSS" using the [◀],[▶] buttons.

4 PRESS [ENTER]

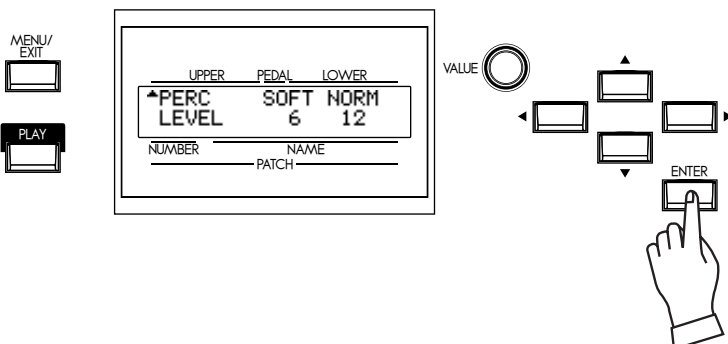

Press the [ENTER] button. The display shows the first page of the Percussion function mode.

5 MOVE THE CURSOR TO THE PARAMETER YOU WANT TO CHANGE

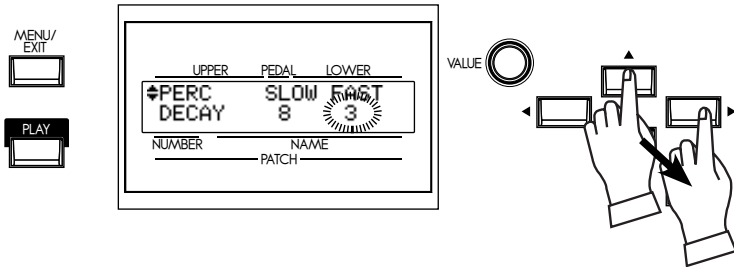

Decay time is on the “DECAY” page. Locate the “DECAY” page using the [▲][▼] buttons.

“FAST” is on the right side of the page move the cursor (blinking value) to the right using the [◀][▶] buttons.

6 CHANGE THE VALUE

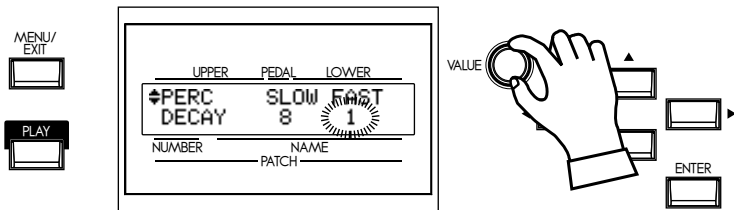

Decrease the value using the [VALUE] knob.

NOTE: If you want to change other items, repeat the process 1 to 6.

7 RETURN TO THE PLAY MODE

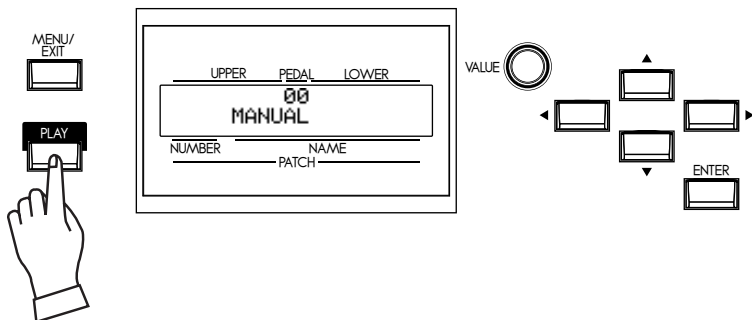

Press the [PLAY] button. The display returns to the PLAY mode.

8 RECORD TO THE PATCH IF NECESSARY

The parameter “DECAY FAST” is a patch parameter, so, if you call another (or same) patch, it is changed to the newly set value.

If you need the changed value hereafter, you must record it to a patch.

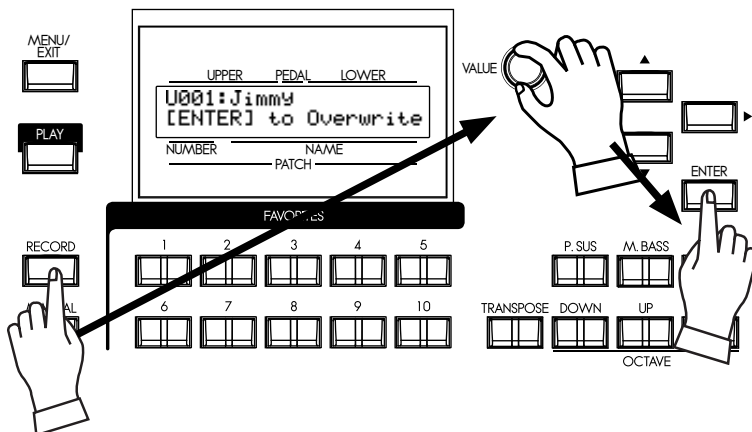

tips PATCH PARAMETERS

Patch Parameters are unique to the current patch, and change with the programming of each patch. Many of the knobs/buttons on the top panel are “Patch Parameters”

The Parameters common to all the patches are called “Global Parameter”, on the contrary.

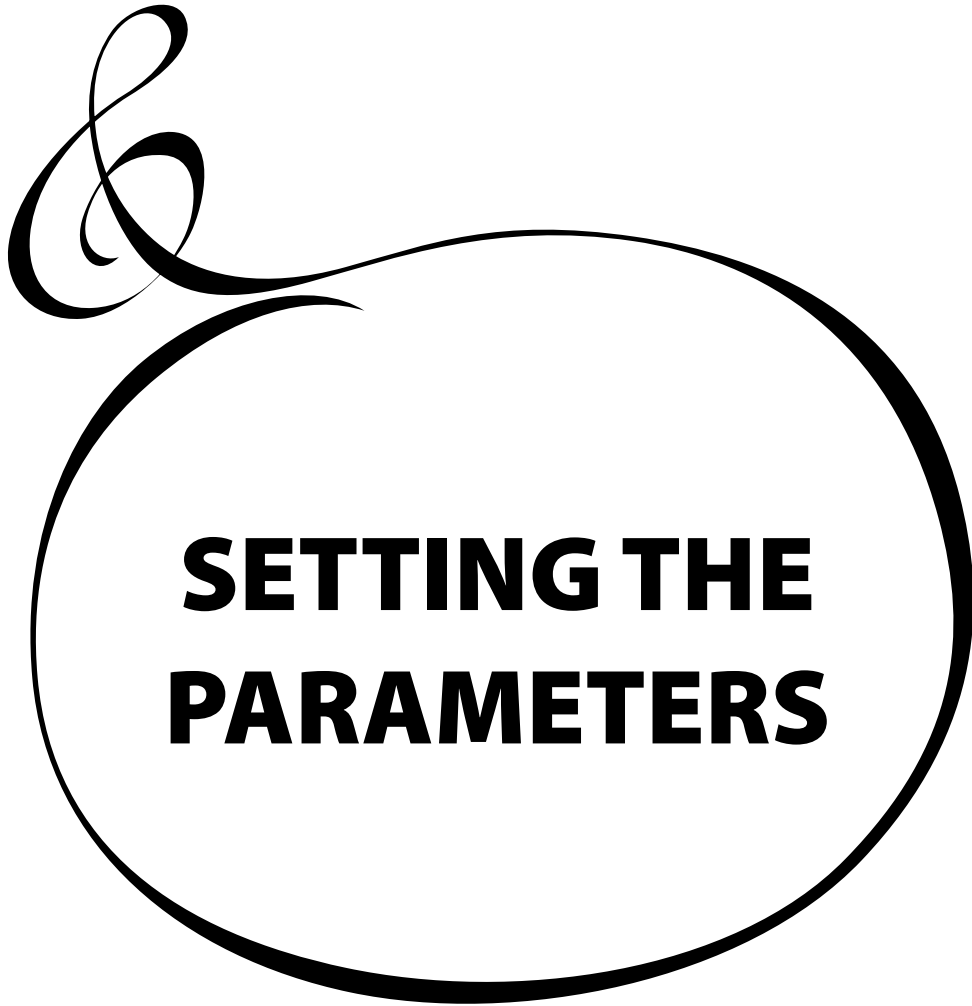
A decorative graphic featuring a treble clef on the left side, with a thick black line that curves from the clef to form a large, rounded oval frame. Inside this frame, the text "SETTING THE PARAMETERS" is written in a bold, black, sans-serif font, centered horizontally and vertically.

**SETTING THE
PARAMETERS**

DRAWBAR

Drawbar sound parameters for each keyboard are set in this mode.

To locate this mode:

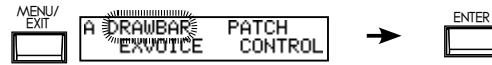

See the "Function mode" (P. 68) for operational details.

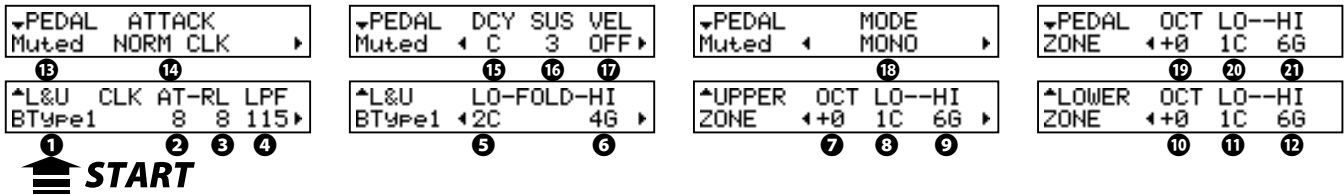

◆ SETTING FOR MANUAL (LOWER & UPPER) DRAWBARS

❶ ORGAN TYPES

Select the manual keyboard organ type.

- BType1:** Traditional B-3/C-3 tone-wheel sound
- BType2:** Sound with more leakage noise and wow-flutter
- Mellow:** With transparent sine waves
- Vx:** Transistor Organ, Vx type
- Farf:** Transistor Organ, Farf type
- Pipe:** Pipe Organ

When the organ type is set at Vx, Farf, or Pipe, the parameters (2) to (6) are unavailable.

❷ CLICK - ATTACK LEVEL

Sets the key-on click volume.

The higher the value, the louder the click gets. No key-click at 4. As the value goes lower than 4, the attack rate becomes slower.

❸ CLICK - RELEASE LEVEL

Sets the key-off click volume.

The higher the value, the louder the click gets. No key-click at 4. As the value goes lower than 4, the release rate becomes slower.

❹ CLICK - LOW PASS FILTER

Sets the key-click tone.

The setting range is 0 to 127. The higher the value, the brighter the sound.

❺ FOLDBACK - LOW

Sets the key-point from which the 16' Drawbar folds back (= repeat the same octave on the lower octaves of the keyboard).

The bottom key on the keyboard is displayed as "1C". The setting range is 1C to 2C.

❻ FOLDBACK - HIGH

Sets the key from which the 1' Drawbar folds back (= repeat the same octave on the higher octaves).

The setting range is 4G to 5C.

NOTE: The Fold-back is possible not only with 1' but also with 1½', 1¾', 2', 2½' Drawbars.

❼ UPPER ZONE OCTAVE

Set the octave shift for the UPPER part. The setting range is -2 to +2.

❽ UPPER ZONE LOW

❾ UPPER ZONE HIGH

Set the sounding range of the UPPER part with these two parameters.

tips TONE-WHEEL SET

There are variations available for each virtual Tone-Wheel set of BType1, BType2 and Mellow. (P. 87)

tips KEY CLICK

On the traditional models such as B-3/C-3, a noise occurred when keys were pressed and released, due to the mechanical keying system employed on the classic organs. That characteristic is replicated here.

Loudness

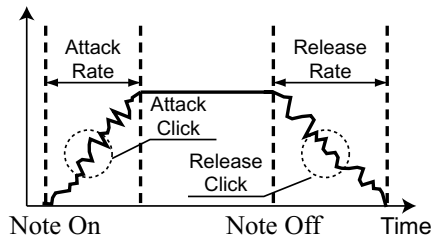

tips

EXAMPLES OF KEY-CLICK SETTINGS

Simulation of classic multi-contact keyboard B-3 and C-3: AT = 8, RL = 8

Simulation of a PCM synthesizer to produce the key-click only at 'attack': AT = 8, RL = 4

Slow envelope like a pipe-organ: AT = 0, RL = 0

tips FOLD-BACK

As the number of the Tone-Wheels was limited on the B-3/C-3, the very highest and lowest pitches "folded back" on the keyboards, sounding the same octave twice in a row. This function reproduces this characteristic.

10 LOWER ZONE - OCTAVE

Set the octave shift for the LOWER part. The setting range is -2 to +2.

11 LOWER ZONE - LOW**12 LOWER ZONE - HIGH**

Set the sounding range of the LOWER part with these two parameters.

◆ SETTING THE PEDAL PART**13 ORGAN TYPE**

Set the Organ type for the Pedal part.

- Normal:** The traditional tone wheel sound of the B-3/C-3.
- Muted:** Analog oscillating sound as heard on the Classic X-5.
- Synth1:** Saw-tooth waveform with the filter-sweep.
- Synth2:** Dull square wave.

When the "Pipe" Organ type is selected by (1), only Pipe Organ pedal sounds are heard, regardless of this parameter. Also, parameters (14) to (17) are unavailable.

14 ATTACK

This allows you to set the Pedal Attack Rate and the Key-Click Volume at 'attack' and 'release'.

- MAX CLK:** Immediate attack and the key-click is loud.
- NORM CLK:** Immediate attack and the key-click is normal.
- SOFT CLK:** Immediate attack and the key-click is soft.
- NO CLK:** A slightly slower attack without key-click.
- SLOW ATK:** Slow attack without key-click.

15 DECAY RATE

This allows you to determine whether the Pedal voice remains at the same volume as a note is held, or if the voice decays, as like a plucked string.

The setting range is 1 - 5 and C. The higher the value, the longer the decay time. There is no decay at C.

16 SUSTAIN LENGTH

This allows you to set the Release Rate (= the decay time after key release), when the [P. SUS] button is ON.

1 is the shortest, and 5 is the longest decay time.

NOTE: You can locate this page by holding down the [P. SUS] button as well.

17 VELOCITY

This allows you to set the response to the Velocity. The setting range is OF and 1 - 4. At OFF, the volume does not change however hard you play the key. As the value increases from 1 - 4, the sounds gets louder even if the key is played softly.

18 KEY MODE

This allows you to set the Pedal polyphony.

- POLY:** Makes it possible to play chords (up to 3 notes).
- MONO:** Only the lowest note will sound, when you play a chord.

19 PEDAL ZONE - OCTAVE

Set the octave shift for the Pedal part. The setting range is -2 to +2.

20 PEDAL ZONE - LOW**21 PEDAL ZONE - HIGH**

Set the sounding range for the PEDAL part with these two parameters.

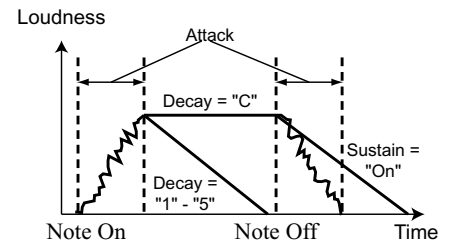
**tips SUSTAIN**

Unlike synthesizer nomenclature, on this keyboard "Sustain" refers to note decay after note release. On a synth envelope generator this setting would be called "T4" or "Release".

tips ZONE

The "ZONE" set in these modes is the setting of the sounding range for each part of the organ section.

See page 108 for details.

NOTE: All the parameters in these modes are Patch Parameters. They are recorded into the Patch.

PATCH

In this mode you can name your patch, set which parameters load, and how to link to the Favorite buttons.

To locate this mode:

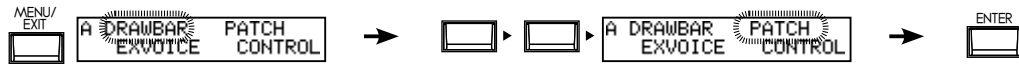

See the "Function mode" (P. 68) for operational details.

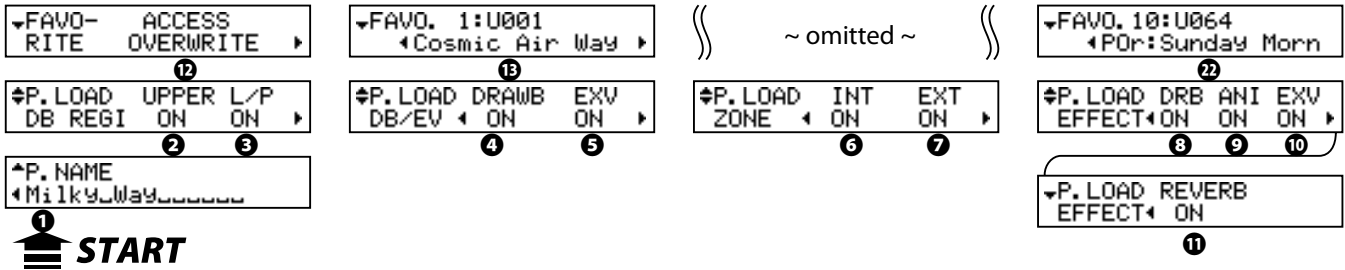

◆ PATCH NAME

① Patch Name (P)

Name the present patch using up to 15 letters.

Move the cursor by the [◀][▶] buttons. Then select letters with the [VALUE] knob.

The patch name is lost, unless you save the patch.

NOTE: This parameter (P) is a patch parameter. It is recorded in each patch.

◆ PATCH LOAD

These are for setting which parameters are loaded when a patch is called. Sets whether or not to load:

② PATCH LOAD - UPPER Registration (G)

Drawbar registration of the UPPER part.

③ PATCH LOAD - LOWER/PEDAL Registration (G)

Drawbar registration of the LOWER and PEDAL parts.

④ PATCH LOAD - DRAWBAR (G)

The parameters specific to the Organ Section such as organ type or percussion.

⑤ PATCH LOAD - EXTRA VOICES (G)

Extra Voice parameters.

⑥ PATCH LOAD - INTERNAL ZONE (G)

The parameters relating with Internal Zone or Coupler (Pedal to Lower and Manual Bass).

⑦ PATCH LOAD - EXTERNAL ZONE (G)

The parameters specific to the External Zone to control external MIDI equipment.

⑧ PATCH LOAD - DRAWBAR EFFECT (G)

The parameters specific to the Organ Section Effects (Overdrive, Multi-Effects, Equalizer).

⑨ PATCH LOAD - ANIMATION (G)

The parameters specific to the Leslie, Vibrato & Chorus effects.

⑩ PATCH LOAD - EXTRA VOICE EFFECTS (G)

The parameters specific to the Extra Voice Section Effects (Overdrive, Multi-Effects and Equalizer).

⑪ PATCH LOAD - REVERB (G)

The Reverb parameters.

NOTE: Each Patch Load parameter is a global parameter. It is recorded when the value is set. Common for each patch.

◆ FAVORITES

⑫ FAVORITE ACCESS (G)

This is for setting the action of the Favorite Buttons.

ASSOCIATE:

Each number button usually calls the related patch.

If you touch each number button holding down the [RECORD] button, it relates the number button to the currently selected patch.

OVERWRITE:

In addition to above, if you touch each number button holding down the [RECORD] button, it records the current setting to the selected patch.

LOCKED1-10:

Each number button usually calls the corresponding patch, 1 ... 10.

If you touch each number button holding down the [RECORD] button, it records the current setting to the corresponding patch, 1 ... 10.

DIRECT:

This is for directly calling the patch, using each number button. To call the patch, first put in the 3 digit patch number and then touch the [ENTER] button.

U001 ... [1], [ENTER]

U010 ... [1], [10], [ENTER]

U100 ... [1], [10], [10], [ENTER]

P001 ... [1], [10], [1], [ENTER]

P010 ... [1], [1], [10], [ENTER]

P100 ... [2], [10], [10], [ENTER]

You can not relate the patch to each number button.

⑬ to ⑳ FAVORITE PATCHES (G)

Displays and changing the patches related with each Number button.

You can enter the these page by pressing and hold the [1] - [10] button also.

NOTE: "G" means "Global". These parameters will be recorded when set, and are common in each Patch.

In this mode the basic Extra Voice settings are made such as the extra voice tone and volume.

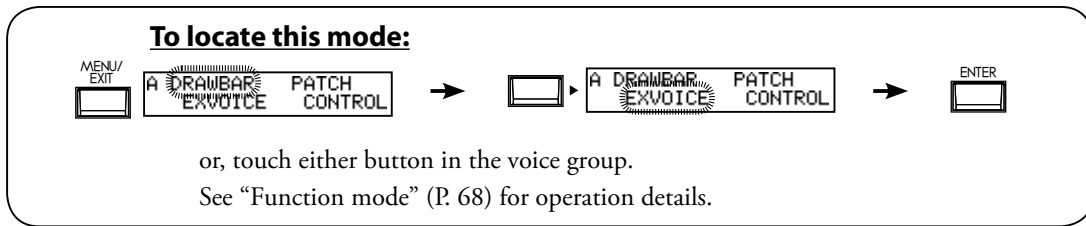

1 ZONE - OCTAVE

Sets the playing octave for the Extra Voice section.
The setting range is -2 to +2.

2 ZONE - LOW

3 ZONE - HIGH

Sets the sounding range in the Extra Voice section with these two parameters.

4 VOICE GROUP

Sets the Voice group. Choices are in the range of “A. Piano” to “Library”, same as the [VOICE GROUP] buttons on the top panel.

The operation of this parameter is different with which [VOICE GROUP] button is selected.

A.PIANO:

Selects “A. Piano”, “A. Piano 2”.

E.PIANO, KYBD, WIND, OTHER:

According with each [VOICE GROUP] button, not selectable.

LIBRARY:

Selects the loaded voice library. “Tr. Organ VxJ” is pre-loaded.

5 INSTRUMENT

Selects the instrument in the voice group.

Consult the instrument list at the back of this manual (P. 136) for details.

6 VOLUME

Adjust the volume of the Extra Voice section here. It is linked with the [VOLUME] knob on the top panel.

The setting range is 0 to 127.

7 VELOCITY

Sets the response to the velocity (strength of the key touch) of the Extra Voice section.

The setting range is OFF, 1 to 4. At OFF keys sound at a certain volume, regardless of the key touch strength (like an organ’s touch). At 1 to 4, the harder you strike the key, the louder it sounds (like a piano keyboard).

8 EXPRESSION

Sets the enable or disable the Expression control. At ON, Expression controls both Organ and Extra Voice section. At OFF, Expression controls only the Organ section.

NOTE: The parameters in this mode are patch parameters, and are recorded to each patch.

tips

OPERATING THE A.PIANO AND LIBRARY

The [A.PIANO] and [LIBRARY] button contains the 2 or more Voice groups. You can select this by pressing the each [A.PIANO] or [LIBRARY] button again instead of the turning the [VALUE] knob at the VOICE GROUP parameter.

tips

LINK BETWEEN INSTRUMENTS AND OTHER PARAMETERS

When an instrument is selected, each parameter of the Octave, the Multi-Effects, the Equalizer and the Prochord (although not displayed), is automatically set at the recommended value.

CONTROL

This mode is for setting the controller.

Please insure that the Expression Pedal and Foot Pedal are properly connected before adjusting their settings, it is also possible to assign the octave buttons to other functions.

To locate this mode:



or, touch the [CONTROL] button.

See “Function mode” (P. 68) for operation details.

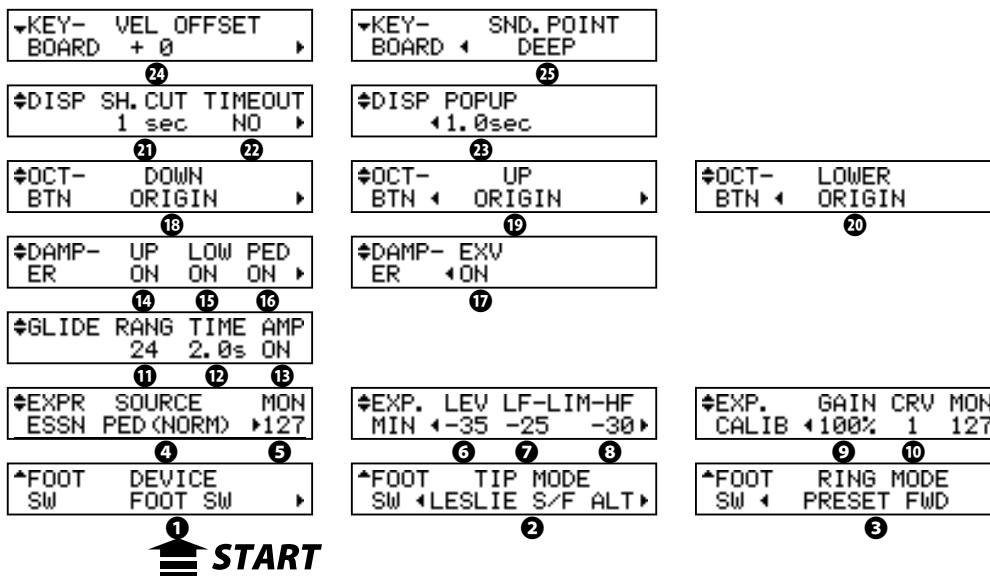

START

◆ FOOT SWITCH

❶ FOOT SWITCH - DEVICE (G)

This is for selecting the equipment connected to the FOOT SWITCH jack.

FOOT SW: Foot Switch connected.

CU-1: Optional Leslie Mode Switch (CU-1) connected.

❷ FOOT SWITCH - TIP MODE (G)

This sets the Foot Switch function.

OFF: Does not function.

LESLIE S/F ALT, MOM, TRI:

Switches the Leslie Effect Slow/Fast/Stop.

At **ALT**, Fast / not (Slow or Stop - it set by [STOP] button) is toggled every time the foot switch is pressed. At **TRI**, it is switched to Stop when the foot switch is further held down for longer than a second.

At **MOM**, it is switched to Fast only while the foot switch is held down. When released, it is switches to not (Slow or Stop - it set by [STOP] button).

GLIDE:

The pitch bends while the foot switch is pressed down the interval is determined by a parameter setting.

PATCH FWD, REV:

Switches the Patch Forward or Reverse.

FAVORITE FWD, REV:

Switches the Favorite Forward or Reverse.

SPRING:

This generates the sound of the spring reverb being shaken.

DELAY TIME:

This is for setting the delay time (P. 101) of the Reverb, at the interval of pressing the foot switch. The delay sound goes out, while the foot switch is held down.

MUSIC START:

Controls the Start/Stop of the music player.

tips TIP AND RING

The typical stereo plug, there are 3 metal parts. The end is called the “Tip”, the middle portion is the “Ring”. The part on the cord side is called the “Sleeve”.

This keyboard requires a foot switch that uses a Stereo Jack. Two Mono-Jack foot switches may be used, and can have discrete functions, if a Left/Right stereo splitter is used.

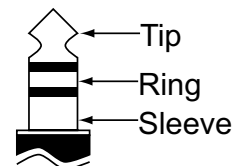

tips SPRING REVERB

The Hammond Organ company actually invented the spring reverb for its organs in the 1940's. The effect was obtained with a length of spring and a few pickups. If the spring was disturbed, it would make a large crashing noise that was usually considered a nuisance, but sometimes was used as a program sound effect. The Reverb here is digital, but the “crash” effect is re-created here.

MANUAL BASS:

Triggers the Manual Bass note of Pedal part.

BASS 1C - BASS 3C

Triggers the specified note of Pedal part.

③ FOOT SWITCH - RING MODE (G)

This sets the Ring side function, when the foot switch connected to the foot switch jack is of the TRS specifications.

◆ EXPRESSION**④ EXPRESSION - SOURCE (G)**

Sets the source of expression control.

PED (NORM):

For the (Optional) Hammond-Suzuki EXP-50 pedal etc.

PED (REV):

For using a Korg XVP-10 type of Expression Pedal etc.

MIDI: For using expression information received at the UPPER keyboard channel.

⑤ EXPRESSION - MONITOR

Displays the current value of expression. In case of no sound or no change when the expression pedal is pressed, this monitor shows whether the expression value changes or not, so you may discover the cause of trouble (if any). This can also be an indicator when playing from low volume to fade in.

⑥ EXPRESSION - MINIMUM LEVEL (G)

Sets the volume at minimum expression.

The setting range is OFF, -40dB to 0dB. At OFF the instrument is silent when Pedal is at Minimum (all the way back). The other value points represent the lowest volume that will be present at the Pedal's minimum position.

⑦ EXPRESSION - LIMIT LOW FREQUENCY (G)**⑧ EXPRESSION - LIMIT HIGH FREQUENCY (G)**

Sets the amount of Low or High Frequency to remain, when the expression is set at minimum.

The setting range is OFF, -40dB to 0dB. At OFF the sound totally disappears, but at other value points the set volume is kept, even if the expression is at minimum.

⑨ EXPRESSION - GAIN (S)

Sets the gain (range) of the connected expression pedal.

Depending on the type of the connected expression pedals, the expression value may not change. In such case, adjust this parameter to obtain the desired response.

⑩ EXPRESSION - CURVE (S)

Adjusts change of expression value corresponding to the angle of the depressed expression pedal.

The setting range is 1 to 3. Refer each curve to the bottom right illustration or try playing live to discern which curve is correct for you.

NOTE: The parameters indicated (S) are system parameters. They are recorded when set, and are common in each Patch.

◆ GLIDE**⑪ GLIDE - RANGE (P)**

Sets the bend range of pitch by semi-tone. Setting range is -24 to +12.

⑫ GLIDE - TIME (P)

Sets the time from the start of glide to reach the pitch set at (11). The setting range is 0.1 to 5.0 seconds.

⑬ GLIDE - AMP (P)

Engages a "fade" along with the Glide, where the volume drops in tandem with the pitch to total silence.

tips**3RD PARTY EXPRESSION PEDAL**

When using a Korg XVP-10 type of pedal, connect the EXPRESSION jack of the XVP-10 to the EXP. PEDAL jack of the this keyboard with a stereo (TRS) cable.

tips**EXPRESSION LIMIT**

One of the human ear's characteristics is that when the volume falls, the sound of the high or low frequencies becomes difficult to hear. Using expression limit, you can hear the revised frequency response.

Vintage B-3 preamps age in different ways-one symptom is the organ's timbre may change with Expression pedal travel. This is a desirable characteristic for some.

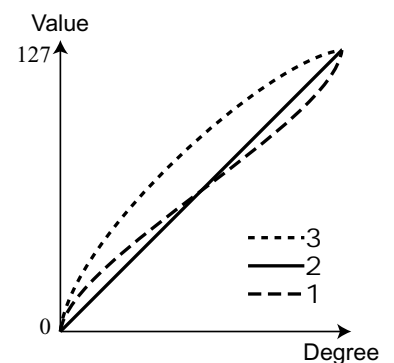
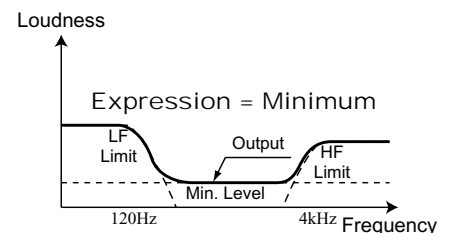
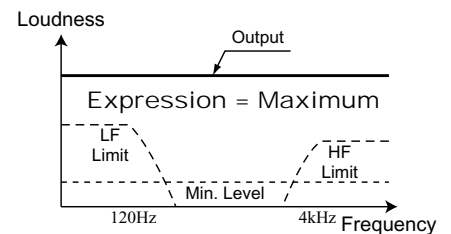

NOTE: The parameter with (P) indicated is a patch parameter, and is recorded to each patch. (G) indicates "global parameter", which is recorded upon being set, and is common with each patch.

↙KEY- VEL OFFSET BOARD + 0 ▶ 24	↙KEY- SND. POINT BOARD ◀ DEEP 25	
⇄DISP SH. CUT TIMEOUT 1 sec NO ▶ 21 22	⇄DISP POPUP ◀1.0sec 23	
⇄OCT- DOWN BTN ORIGIN ▶ 18	⇄OCT- UP BTN ◀ ORIGIN ▶ 19	⇄OCT- LOWER BTN ◀ ORIGIN 20
⇄DAMP- UP LOW PED ER ON ON ON ▶ 14 15 16	⇄DAMP- EXV ER ◀ON 17	
⇄GLIDE RANG TIME AMP 24 2.0s ON 11 12 13		
⇄EXPR SOURCE MON ESSN PED (NORM) ▶127 4 5	⇄EXP. LEV LF-LIM-HF MIN ◀-35 -25 -30 ▶ 6 7 8	⇄EXP. GAIN CRV MON CALIB ◀100% 1 127 9 10
^FOOT DEVICE SW FOOT SW ▶ 1	^FOOT TIP MODE SW ◀LESLIE S/F ALT ▶ 2	^FOOT RING MODE SW ◀ PRESET FWD 3

 **START**

◆ **DAMPER**

- 14 **DAMPER - UPPER (G)**
- 15 **DAMPER - LOWER (G)**
- 16 **DAMPER - PEDAL (G)**
- 17 **DAMPER - EXTRA VOICES (G)**

Assigns the DAMPER to the various divisions of the Instrument.

(14) (15) and (16) are for setting each part of the Organ section, and (17) is for the Extra Voices.

◆ **ASSIGN**

- 18 **OCTAVE BUTTON - DOWN (G)**
- 19 **OCTAVE BUTTON - UP (G)**
- 20 **OCTAVE BUTTON - LOWER (G)**

Used to assign extra functions other than the original ones to the [OCTAVE] buttons.

ORIGIN:

Works according to the buttons' original function.

LES STOP, LES FAST:

Similar to the [LESLIE STOP], [LESLIE FAST] buttons.

VIB UPPER, VIB LOWER:

Similar to the [VIBRATO UPPER], [VIBRATO LOWER] buttons.

GLIDE:

This is for activating the Glide function.

SPRING:

This is for producing the shock noise of the Spring Reverb.

DELAY TIME:

Sets the Delay Time (P. 101) by tapping the button at the speed you wish the delay to be set. If you keep pressing the button, the Delay sound disappears.

tips **DAMPER**

Or "Sustain" pedal-analogous to the RIGHT pedal on a piano. Sounds are held when this pedal is depressed. Called "Damper" due to the fact that when the pedal was depressed on a piano, the mechanism that muted or "damped" the strings was raised, allowing the piano strings to ring free.

◆ DISPLAY

21 DISPLAY - SHORT CUT (G)

Sets the short cut waiting time.

The setting range is 0 to 2 seconds. At NO the short cut feature is disabled.

22 DISPLAY - TIME OUT (G)

Sets the time for returning to the previous mode from the mode displayed by the short cut operation.

The setting range is 4 to 16 seconds. At NO the screen will not return to the previous mode.

23 DISPLAY - POP UP (G)

Sets the interval at which the Pop Up is displayed when you move the [OVERDRIVE] or [EFFECT AMOUNT] knob.

The setting range is 0.5 to 2 seconds. At NO no Pop Up is displayed.

◆ KEYBOARD

24 VELOCITY OFFSET (S)

Fine-adjusts the keyboard velocity to personal taste. the setting range is -32 to +32. If your touch is heavy, set this parameter to a negative value, if your touch is light, set the parameter to a positive value.

25 SOUNDING POINT (S)

Set the sounding point if the internal keyboard is played.

DEEP All the section sounds on the deep point in the stroke.

AUTO The Organ section sounds on the shallow point if the [ALLOCATE] of the Extra Voice section is OFF.

NOTE: The External Zone notes on at shallow point, and the velocity value is fixed at 100 when the Sounding Point is set at AUTO, and the [ALLOCATE] is OFF.

NOTE: The parameter with (P) indicated is a patch parameter, and is recorded to each patch. (G) indicates "global parameter", (S) indicates "system parameter", which is recorded upon being set, and is common with each patch.

PERCUSS (Percussion)

This mode is for setting the parameters of the percussion sounds.

To locate this mode:

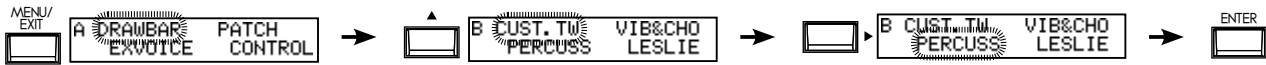

or, keep pressing either of the [SECOND], [THIRD], [FAST], [SOFT] buttons for a moment.

See “Function mode” (P. 68) for operation details.

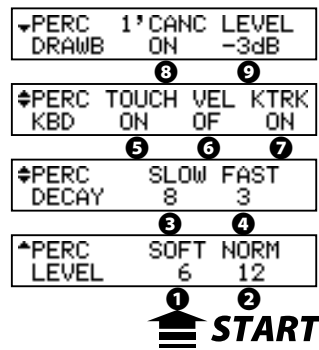

1 LEVEL SOFT

2 LEVEL - NORMAL

Controls the percussion volume levels. The Normal level is set by the NORM setting, and SOFT is the level when the [SOFT] button is ON.

3 DECAY - SLOW

4 DECAY - FAST

Controls the percussion decay time. The Slow rate is set by SLOW setting, and FAST is the time when the [FAST] button is ON.

The setting range is 1 to 9 and C. As the value is raised, the decay time grows longer. At C (continuous) there is no decay, and the percussion sound is sustained while keys are pressed.

5 KEYBOARD - TOUCH

Sets the touch response of the percussion.

ON: Legato playing will result in the First note hit engaging the percussion, and none after.

OFF: The envelopes reset with each key hit and percussion sounds on every note.

6 KEYBOARD - VELOCITY

Links the percussion volume to velocity.

ON: A harder strike produces a louder percussion sound.

OFF: Regardless how hard you play, the volume remains the same.

7 KEYBOARD - KEY TRACK

Attenuates the percussion volume by keyboard position.

ON: The higher the note is, the lesser the volume.

OFF: no change in volume.

8 DRAWBAR - 1' CANCEL

Mutes the UPPER 1' Drawbar while using the percussion.

ON: Mute active

OFF: No mute.

9 DRAWBAR - LEVEL

Reduces the UPPER Drawbar volume while using the percussion (except [SOFT] button is ON).

-5dB: Reduces the volume in similar response to the classic B-3/C-3.

-3dB: Slight reduction in volume.

0dB: Does not reduce the volume.

NOTE: All the parameters of these modes are patch parameters, and are recorded to the respective patches.

tips TOUCH

The percussion generator on the vintage B-3/C-3 had a single envelope, which would not recycle until all keys were raised. Originally thought to be a defect, the resulting response became a desired trait.

tips 1' CANCEL

The B-3/C-3 had no exclusive key contact for the percussion, but, used the 1' contact. This is simulated on this keyboard.

tips DRAWBAR LEVEL

When the percussion was activated on the B-3/C-3, the volume of the Drawbars became slightly softer in volume. This is simulated on this keyboard.

In this mode, the settings specific to Vibrato and Chorus are adjusted.

To locate this mode:

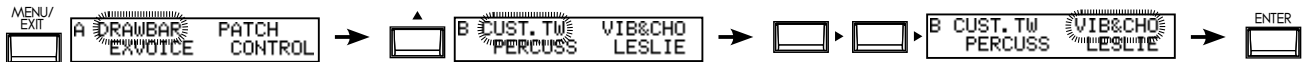

or, keep pressing either of the [V1/C1], [V1/C2], [CHORUS], [ON UPPER], [ON LOWER] buttons for a few seconds.

See “Function mode” (P. 68) for operation details.

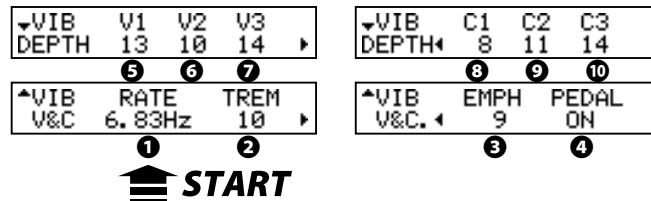

1 RATE

Sets the Speed of the Vibrato and Chorus effect.

The setting range is 6.10 - 7.25 Hz.

2 VIBRATO - TREMOLO

Sets Tremolo (amplitude modulation) of the Vibrato and Chorus effect.

The setting range is 0 - 15.

3 EMPHASIS

Sets Emphasis (high frequency boost) of the Chorus effect (C1 / C2 / C3).

The setting range is 0 - 9 dB.

4 PEDAL

Sets Vibrato and Chorus affects on the Pedal part by [LOWER] button.

The setting range is ON/OFF.

5 DEPTH V1

6 DEPTH V2

7 DEPTH V3

8 DEPTH C1

9 DEPTH C2

10 DEPTH C3

Sets the Depth of each Vibrato and Chorus effect mode.

The setting range is 0 - 15.

NOTE: The parameters in these modes are Preset Parameters and are recorded to each Preset.

tips CHORUS EFFECT

The Hammond Chorus/Vibrato is not an everyday DSP effect. It is a re-creation of the vintage mechanical scanner that was included on-board the classic B-3, through executed in the digital realm.

tips PEDAL

On the vintage B-3/C-3, the Vibrato and Chorus affects not only Lower part but also Pedal part via [LOWER] (exactly, “GREAT”) tablet by the circuit structure. It is divided on later models.

This parameter simulates that.

NOTE: All the parameters in these modes are Patch Parameters. They are recorded into the Patch.

In this mode, the settings are made for the built-in Leslie Effect and the External Leslie Speaker.

There are many parameters related to the Leslie functions, to make this easier to edit and use.

The built-in Leslie parameters are grouped in macro-settings called “CABINETS”. You select the CABINET NUMBER in the Combination Presets where this selection is saved as part of the Preset.

To locate this mode:

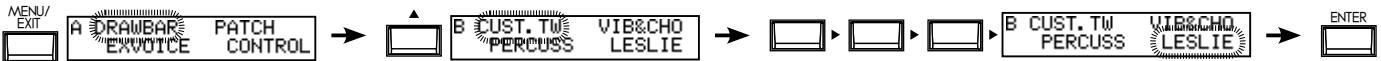

or, keep pressing either of the [BYPASS], [STOP], [FAST] buttons for a few seconds.

See “Function mode” (P. 68) for operation details.

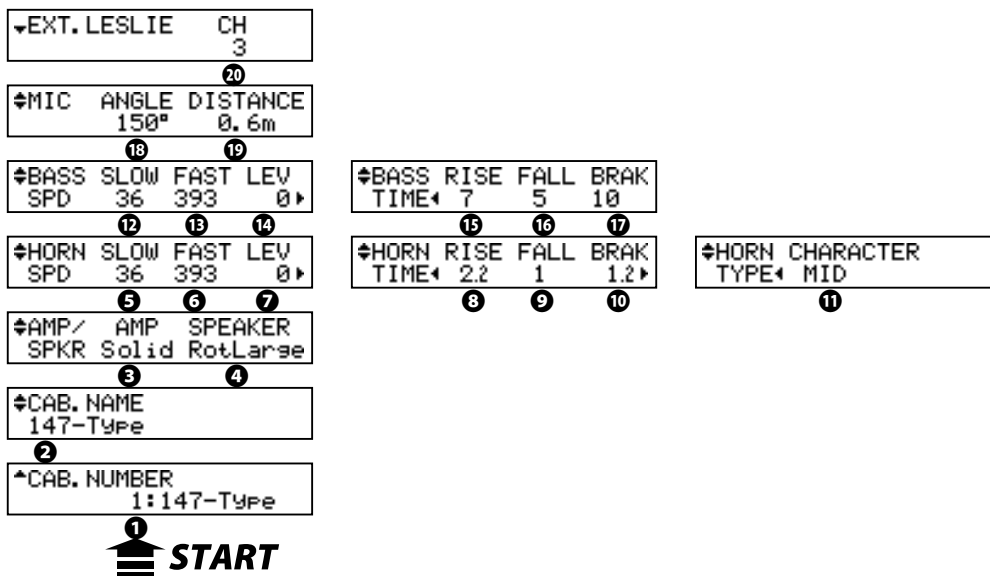

◆ CABINET NUMBER

1 CABINET NUMBER (P)

Selects the Cabinet Number to use in the Patch.

The setting range is P1 to P8 (not-overwritable) and U1 to U8 (overwritable). If the Leslie parameter is changed, “*” is displayed on the left side.

◆ LESLIE PARAMETERS

2 CABINET NAME (L)

Sets the Cabinet Name by up to 10 characters.

Move the cursor with the [◀][▶] button and select letters with the [VALUE] knob. Allowable values are: symbols, digits and the large and small Alphabet.

The name and following (L) parameters are not recorded until the Cabinet Macro is recorded into memory (See the next paragraph.)

3 AMP (L)

This is for setting the type of the virtual Power Amplifier.

Solid: Flat characteristic Amp

Tube: Tube-style amp with Mild characteristics.

4 SPEAKER (L)

This is for setting the virtual Speaker.

RotSmall: A small Leslie speaker, such as the Leslie 145

RotLarge: A large Leslie speaker, such as the Leslie 122

Station: A fixed speaker, such as the Hammond PR-40

tips

CONCEPT OF THE CABINET NUMBER

One Cabinet is equivalent to a virtual Leslie speaker made with the Leslie parameter.

This is a Patch parameter.

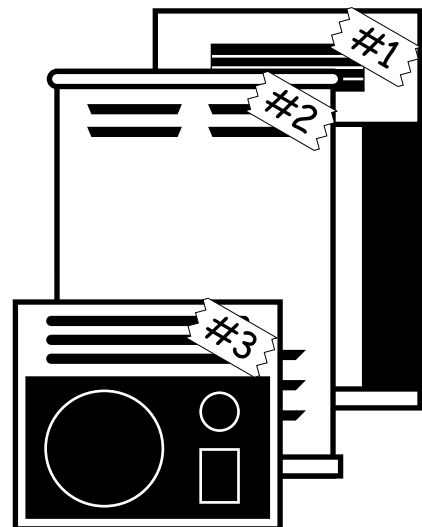

5 SLOW SPEED - HORN (L)

Sets the speed of the rotor at slow mode.

The setting range is 0, 24 to 318 rpm. At 0, no rotation.

6 FAST SPEED - HORN (L)**12 SLOW SPEED - BASS (L)**

Sets the speed of the rotor at the fast mode.

The setting range is 0, 375 to 453 rpm. At 0, no rotation.

7 HORN LEVEL (L)**13 FAST SPEED - BASS (L)**

Sets the volume of each rotor. The setting range is 0 to -12dB.

8 RISE TIME - HORN (L)**14 BASS LEVEL (L)**

Sets the time for the rotors to “ramp up” to the ‘Fast Speed’, when switching from ‘Slow’ or ‘Stop’ to the ‘Fast’ mode.

The setting range for the Horn Rotor is 0.2 to 5.0sec., and the Bass Rotor is 0.5 to 12.5sec.

9 FALL TIME - HORN (L)**15 RISE TIME - BASS (L)**

Sets the time for the rotor to reach the ‘Slow Speed’, when switching from ‘Fast’ to ‘Slow’ mode.

The setting range for the Horn Rotor is 0.2 to 5.0sec., and that for the Bass Rotor is 0.5 to 12.5sec.

10 BRAKE TIME - HORN (L)**16 FALL TIME - BASS (L)**

Sets the time for the rotor to stop, when switching from ‘Fast’ to the ‘Stop’ mode.

The setting range for the Horn Rotor is 0.2 to 5.0sec., and the Bass Rotor is 0.5 to 12.5sec.

11 HORN CHARACTER (L)

Sets the tone of the Horn Rotor.

“FLAT” has no boost or cut in frequencies, and the “MID” or “DEEP” have “peaks” in various tonal ranges, to mimic the particular characteristics of the horns.

18 MIC - ANGLE (L)

Sets the virtual locations of the two virtual microphones for the virtual Leslie Speaker.

The ANGLE decides the distance between the two virtual mikes. The setting range is 0 to 180°. Farther settings exhibit more stereophonic characteristics.

19 MIC - DISTANCE (L)

Sets the distance between the virtual Leslie Speaker and the virtual microphones.

The setting range is 0.3 to 2.7m. Setting the range “further away” will result in a less intense sound.

NOTE: When you operate the parameters 2 to 9, the setting range will be lost after the power is switched OFF, if you do not do the recording operation of the next paragraph.

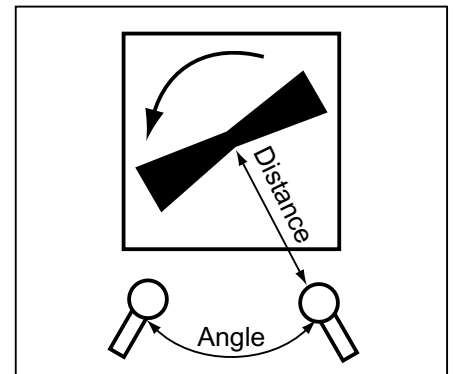
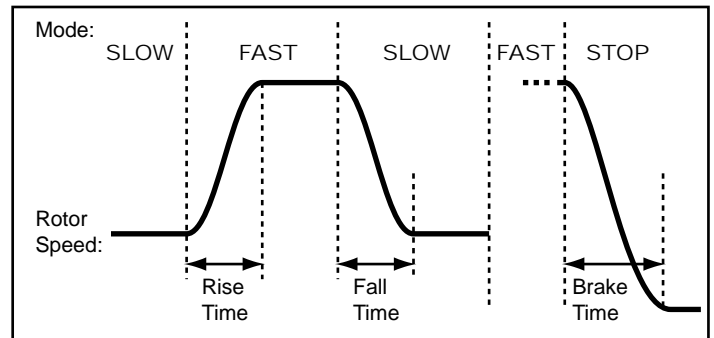

◆ EXTERNAL LESLIE SPEAKER

20 LESLIE CHANNELS

Sets the channel for the Leslie speaker connected to the LESLIE 8-PIN jack.

1ch: For connecting a 1 channel Leslie cabinet such as the 122XB, 3300/W (non-expansion). The Drawbar and the percussion sounds are output only from the rotary channel, the other voices are from the LINE OUT jack.

3ch: This is for connecting a 3 channel Leslie cabinet such as the 2101/mk2. The Drawbar and the percussion sounds are output from the rotary channel, the Extra Voices and bypassed Drawbar and percussion sounds are from the stationary channel of the Main and Aux.

NOTE: This is a system parameter. It is recorded upon setting, and is common with all patches.

RECORD THE CABINET

Record the Leslie Parameter (#2 to #19 on the previous page) to the Cabinet Numbers and use them selecting at the patches.

1



Give a name to the cabinet as desired.

2

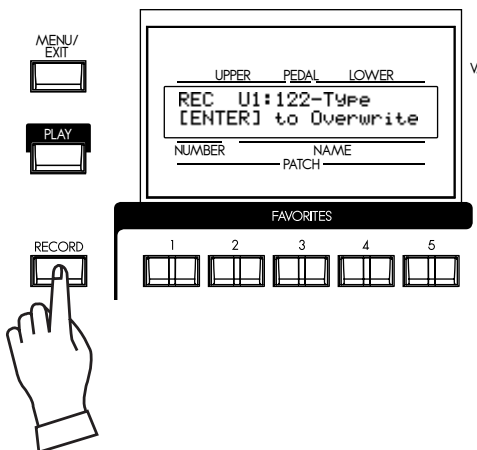

Press the [RECORD] button in the Leslie Parameter setting mode (#2 to #19). The Cabinet Select mode is displayed.

3

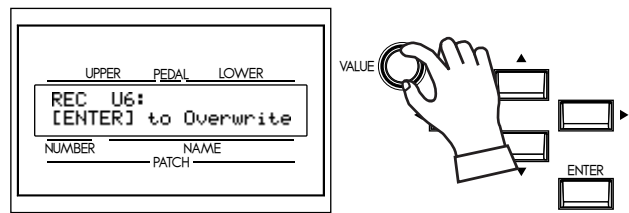

Select the Cabinet Number to record with the [VALUE] knob.

4

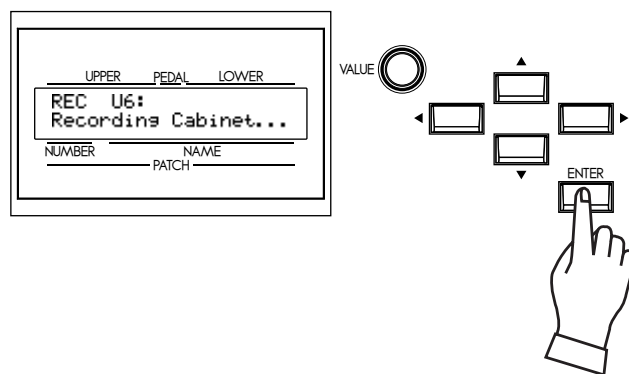

Recording is made upon pressing the [ENTER]. The display is as the above during the treatment. **NOTE: If you don't wish to record, touch the [MENU/EXIT] button.**

In this mode, you select or edit the characteristics of each tone wheel set to be used on the manual keyboards.

To locate this mode:

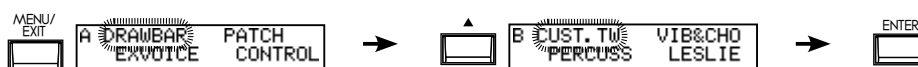

See “Function mode” (P. 68) for operation details.

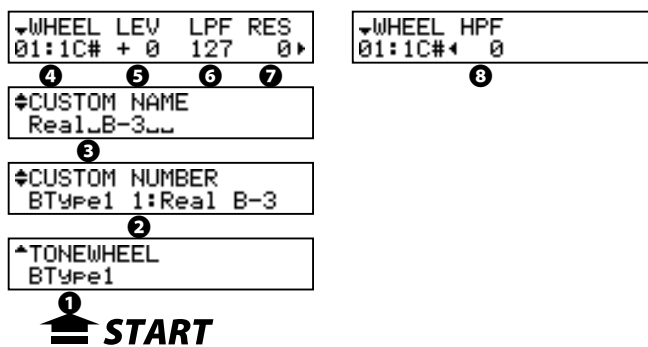

1 TONEWHEEL SET

This is for selecting the virtual Tonewheel set of which “BType1”, “BType2” and “Mellow” are the organ types.

Also, the temporary (= the present setting) automatically switches to the selected virtual Tonewheel set just selected now.

2 CUSTOM NUMBER

This is for selecting the “CUSTOM NUMBER” to use or compile. The “*” will be displayed when the virtual Tonewheel Parameters are changed from this Custom Number.

NOTE: This parameter is a Patch Parameter. It is recorded into the Patch.

3 CUSTOM NAME

You can name the CUSTOM virtual TONEWHEELS set using up to 10 letters.

Move the cursor using the [◀] [▶] buttons and choose the letters using the [VALUE] knob.

The name set here, as well as the Tonewheel Parameters below, will be deleted, if you do not perform the recording operation as explained on the next paragraph.

4 WHEEL NUMBER

Select the Number of the Wheel you want to regulate.

To select the Wheel Number, select the [VALUE] knob here, or slightly move the footage of the Drawbar while pressing the key you want to regulate (see the illustration on the right).

When the Wheel Number is selected, each parameter for the wheel (#5, #6, #7, #8) is displayed.

NOTE: Set the [OCTAVE] and [TRANSPPOSE] at “0” for select the correct wheel number.

tips

INITIAL VALUE OF THE CUSTOM NUMBER

The typical settings are saved to the Number 1 - 3 (or 4), as the initial value.

For example, to the BType1, “Real B-3” simulating the well-preserved B-3/C-3 and “80’s Clean” with less noise, rough sound “Noisy”, and “Noisy 60” with louder leakage noise is stored.

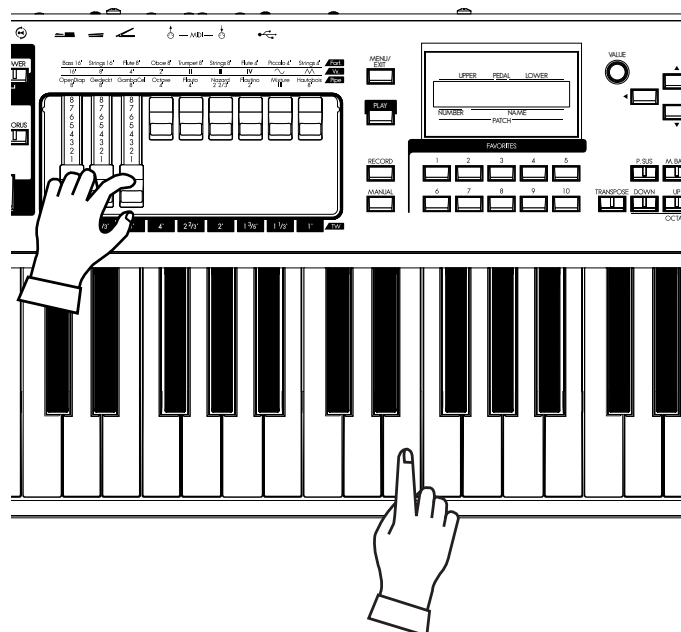

How to select the WHEEL NUMBER

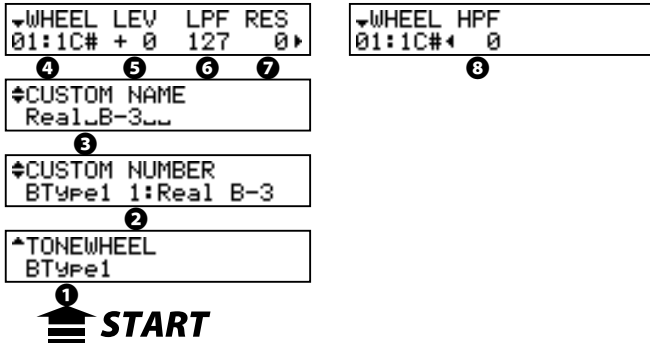

5 LEVEL

This is for setting the volume of a virtual wheel.
The setting range is -20 to +2dB. If you increase the value, it gets louder.

6 CUT OFF FREQUENCY - LPF

This is for setting the FREQUENCY to cut the TREBLE of a virtual wheel.
If you increase the value, a leakage noise is heard besides the original Tonewheel pitch.
If you decrease the value, the sound gets sweet and mild, as the treble is cut off.
The setting range is 0 - 127.

NOTE: If you decrease the value too low below the fundamental Tonewheel pitch, the wheel volume will be reduced.

7 RESONANCE - LPF

This setting boosts or reduces the level of the Cut Off Frequency - LPF (#6).
The setting range is 0 - 127. The higher value boosts treble, and lower values cut treble smoothly.

8 CUT OFF FREQUENCY - HPF

This is for setting the FREQUENCY to cut the BASS of this wheel.
If you decrease the value, a motor hum (= noise) is heard besides the original virtual Tonewheel sound.
The setting range is 0 - 127.

NOTE: If you increase the value too high above the original tonewheel pitch, the sound will get "Thin".

NOTE: The parameters 3 - 8 are the virtual Tonewheel Parameters. If you perform the recording operation of the next page, it works in common with the same virtual Tonewheel set of each Patch.

NOTE: When you operate the parameters 3 - 8, if you do not the perform recording operation on the next page, it is lost when you turn off the power.

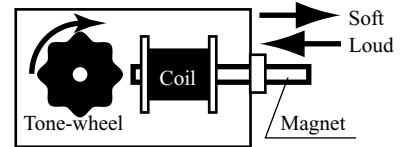

Concept of the LEVEL ADJUSTMENT

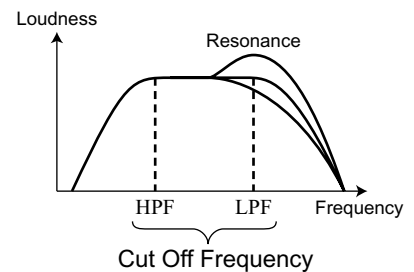

tips LEAKAGE NOISE

In the vintage electro-mechanical Hammonds, sometimes the signal from adjacent tonewheels would be picked up (or "leaked") along with the current tonewheel in play. This "hash" noise, another Hammond anomaly originally considered to be a defect grew to be an integral part of the Hammond sound.

"Mellow" does not include the Leakage Noise.

tips DISTORTION

If you raise the Level and Resonance values too much, it changes the gain in the sound engine and may sometimes cause distortion, i.e. unpleasant noise.

In such a case, please lower these values.

Record the CUSTOM virtual TONEWHEELS

The Tonewheel Parameters (= 3 - 8 of the previous paragraph) are for determining the Custom Number for recording. The Custom Number is selected and used, when you play.

1



Enter the Custom Name if desired.

2

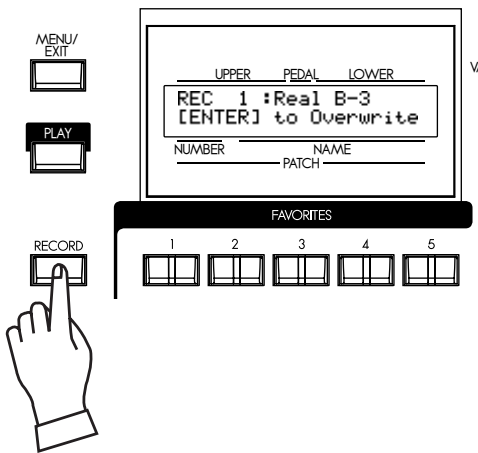

Touch the [RECORD] button in the setting mode of the Tonewheel Parameters.
The mode for selecting the Custom Number to be recorded will be displayed.

3

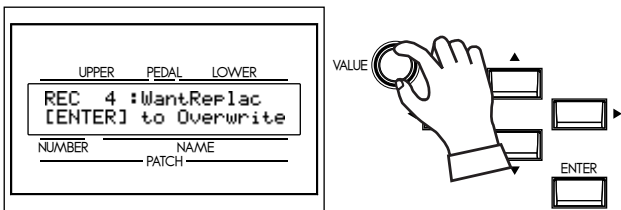

Select the Custom Number to be recorded using the [VALUE] knob.

4

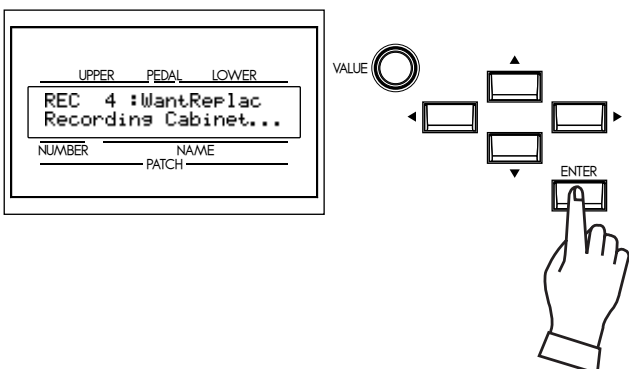

It will be recorded if you touch [ENTER] button.
The display will be as illustrated, while the recording is being written to memory.

NOTE: If you do not want to record it, just touch the [MENU] button.

PIPE

In this mode, you edit the characteristics of each pipe.

To locate this mode:

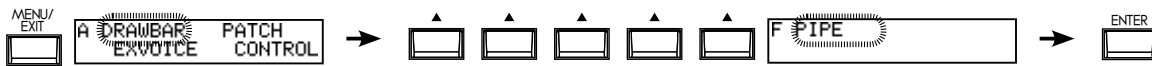

See “Function mode” (P. 68) for operation details.

▼PEDAL 2 VOL DETN
Pc4+Mixt 120 + 2 ▶

▼PEDAL 2 CHIF CUTOFF
Pc4+Mixt◀MID + 0▶

▼PEDAL 2 DIR-PAN-IMG
Pc4+Mixt◀-C- ▶▶INV

... omitted ...

▲UPPER 1 VOL DETN
Bourdn16 96 - 3 ▶

▲UPPER 1 CHIF CUTOFF
Bourdn16◀SOFT + 0▶

▲UPPER 1 DIR-PAN-IMG
Bourdn16◀L20 ▶▶L-R

①

②

③

START

④

⑤

⑥

⑦

① PIPE NUMBER

Select the PIPE which you desire to edit using [▲],[▼] buttons, or move the Drawbar which corresponding the pipe stop.

There are 20 pipes which according to Drawbars from “Bourdon 16” to “Principal Chorus 4’ + Mixture IV” (P. 48).

② VOLUME (Pi)

Adjusts the volume of the pipe. The setting range is 0 to 127.

③ DETUNE (Pi)

Detunes the pitch of pipe from accurate pitch by cent (1/100 of semitones).

The setting range is -50 - 0 - +50.

④ CHIFF (Pi)

Sets the “Chiff” noise of beginning of notes.

OFF: No sounds the chiff noise.

SOFT: Sounds the chiff noise slightly.

MID: Sounds the chiff noise medium.

LOUD: Sounds the chiff noise maximum.

NOTE: Some pipes does not affect the chiff parameter i.e. “Hautbois 8”.

⑤ CUT OFF FREQUENCY (Pi)

Adjusts the tone quality of the pipe.

The setting range is -64 to 0. At 0, all of pipe sounds are heard. The sound becomes mellower by the decreasing the value.

⑥ PAN - DIRECTION (Pi)

Adjusts the basic direction of the pipe.

The setting range is L64 - C - R63 (Left - Center - Right).

tips DETUNE

The beating is heard by sounding detuned pitch on sounding accurate pitch.

Each pipe can be detuned for comfortable beating. But it may become out of tune if too much detune is applied.

Generally, they are effective when set at “-” side for lower octave pipes, set at “+” side for upper octave pipes.

7 PAN - IMAGING (Pi)

Sets the arrangement of the pipe.

FIX: Sounds the FIXEd direction which set by #6 for all notes.

L-R: Sounds Left to Right which according to the keys.

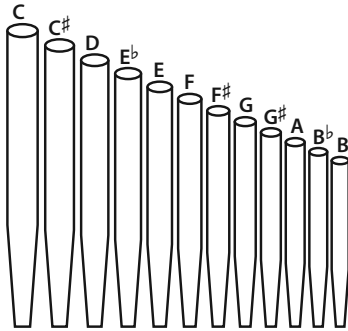

R-L: Sounds Right to Left which according to the keys.

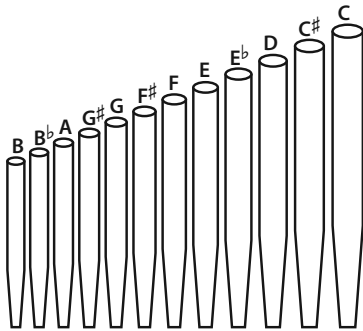

PYR: Like the PYRamid, sounds center to sides which according to the keys.

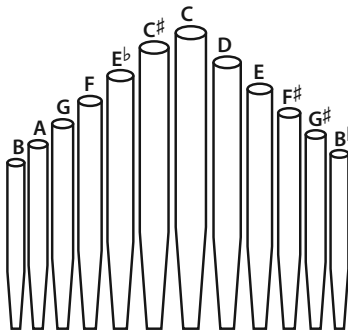

INV: Like the INVerted pyramid, sounds sides to center which according to the keys.

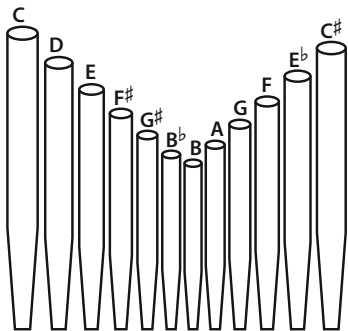

tips PAN AND OUTPUT

The pipe stops are spreaded left and right. Sometimes "makes no sound" or "different volume note by note" with a mono connection to the audio system.

In that case, set the "Audio mode - Output" (P. 104 #1) at "MONO". The volume is equal note by note with panning disabled.

NOTE: The parameters of these modes (Pi) are Pipe parameters. They are recorded when they are set, and are common for each patch.

OD / EFF (Overdrive / Effects)

In this mode, Overdrive and the Multi-Effects are adjusted.

The Organ and Extra Voice Sections have their own independent overdrive and Multi-Effects section.

To locate this mode:



or, keep pressing the [OVERDRIVE], [EFFECT ON] buttons for a few seconds.
See "Function mode" (P. 68) for operation details.

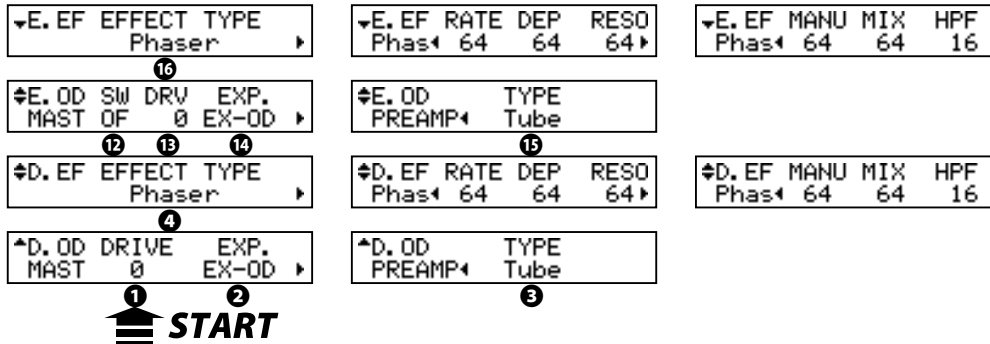

◆ ORGAN SECTION EFFECTS

OVERDRIVE

1 OVERDRIVE - DRIVE

Adjusts the drive component of the Overdrive. The higher you raise the value, more distortion is obtained. It is linked with the [DRAWBARS OVERDRIVE AMOUNT] knob on the top panel.

2 OVERDRIVE - EXPRESSION

Sets whether or not to vary the distortion amount by operating the Expression Pedal.

EX-OD:

If you operate the Expression Pedal, not only the volume but also the distortion amount also varies.

OD-EX:

The effect of the Expression Pedal changes only the volume and the distortion amount does not change.

OD ONLY:

The effect of the Expression Pedal only changes the distortion amount and the volume does not change.

INPUT:

This is similar to "EX-OD", but less of volume change.

3 OVERDRIVE - PREAMP

Sets the characteristic of the Overdrive.

Tube: Replicates the overdrive of a tube-driven amp.

Stomp: Replicates the stomp box.

Clip: Accurate hard clip.

EPAmP: Replicates the pre-amplifier of an electric piano.

MULTI-EFFECTS

4 EFFECT TYPE

Selects the Multi-Effect type. The following effects are built in this keyboard.

Tremolo, Auto Pan, Wah-Wah, Ring Mod., Phaser, Flanger, Chorus, Delay

The parameters for the Multi-Effects are different type by type. The explanation about the types follows:

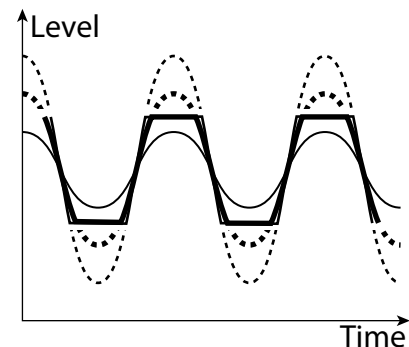

Tremolo

The Tremolo modulates the volume at a set cycle.

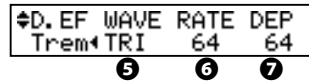
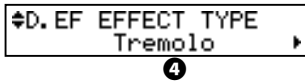

5 TREMOLO - WAVEFORM

Sets which waveform is used to modulate the volume.

- Tri:** Triangle wave. The volume changes smoothly.
- Sqr:** Square wave. The volume suddenly rises and falls.
- Saw:** Sawtooth wave. Repeated decaying sound is obtained.
- S&H:** Sample & hold. The volume changes randomly.
- DSqr:** Dull square wave like the old electric piano effect.

6 TREMOLO - RATE

Adjusts the speed of the tremolo cycle.

The setting range is 0 to 127. The higher the value rises, the faster the cycle becomes. This is synchronized with the [EFFECT AMOUNT] knob on the top panel.

7 TREMOLO - DEPTH

Adjusts the depth of the tremolo effect.

The setting range is 0 to 127. At 0 the volume does not modulate. The higher the value goes up, the deeper becomes the effect. At 127 a repeated no sound/maximum volume is obtained.

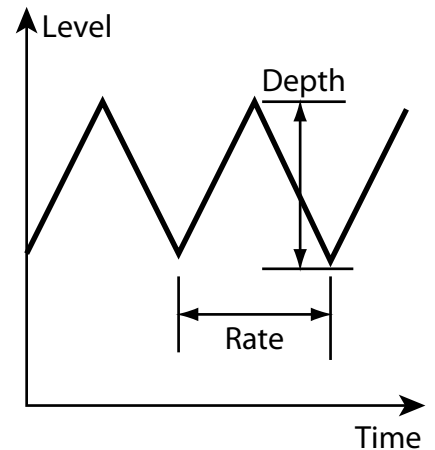

Auto Pan

Auto Pan applies adjustable modulation to the stereo field.

This is not applicable if a monophonic (one channel) amp is used, or when the Leslie effect is used.

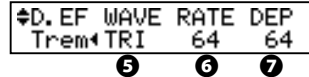
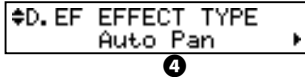

5 AUTO PAN - WAVEFORM

Sets which waveform to modulate the direction.

- Tri:** Triangle wave. The direction smoothly changes.
- Sqr:** Square wave. The direction suddenly moves to the left, and suddenly moves to the right.
- Saw:** Sawtooth waveform. The direction repeatedly moves from left to right.
- S&H:** Sample & hold. The direction changes randomly.
- DSqr:** Dull square wave like the old electric piano effect (recommended).

6 AUTO PAN - RATE

Adjusts the speed of the modulation.

The setting range is 0 to 127. The higher the value rises, the faster the modulation becomes. It is linked with the [EFFECT AMOUNT] on the top panel.

7 AUTO PAN DEPTH

Adjusts the depth of the cycle.

The setting range is 0 to 127. At 0, there is no direction modulation. The higher the value rises, the deeper the effect becomes. At 127 you can give a perfect left/right repetition.

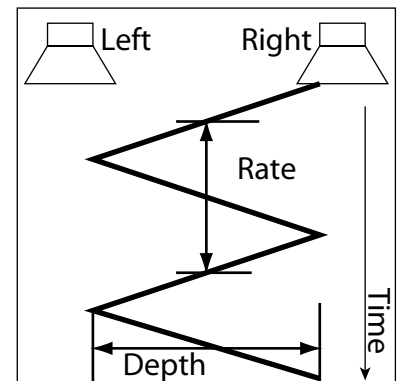

NOTE: All the parameters in these modes are Patch Parameters. They are recorded into the Patch.

Wah-Wah

Wah-Wah imposes a “speech-like” dynamic to the sound.

↔D. EF EFFECT TYPE
Wah-Wah ▶
4

↔D. EF SRC	SENS	RES
Wah ◀LFO	64	64▶
5	6	7

↔D. EF WAVE	RATE	FREQ
Wah ◀Tri	64	64
8	9	10

5 Wah-Wah - SOURCE

Selects the source of the WAH control.

MAN: Uses the FREQ parameters, i.e. the [EFFECT AMOUNT] knob.

EXP: Uses the Expression Pedal like a “Wah Wah pedal”.

LFO: Auto-Wah using the built-in ‘LFO - Low Frequency Oscillator’.

6 Wah-Wah - SENSITIVITY

Sets the sensitivity to change the Wah effect of LFO or Expression Pedal.

It is linked with the [EFFECT AMOUNT] knob on the top panel when the SOURCE (5) is set at EXP.

The setting range is 0 to 127. The dynamic response increases as the value rises.

7 Wah-Wah RESONANCE

Boosts the cut-off frequency range of the Low-pass Filter and gives a more pronounced “Wah” effect.

The setting range is 0 to 127. The resonance increases as the value rises.

8 Wah-Wah - WAVEFORM

When the SOURCE (5) is set at LFO, the LFO wave form is set.

Tri: Triangle wave. The sound smoothly varies.

Sqr: Square wave. The filter suddenly opens and suddenly closes.

Saw: Saw-tooth wave. Repeated changes in the sound are obtained.

S&H: Sample & Hold. Random sound changes are obtained.

9 Wah-Wah - RATE

When the SOURCE (5) is set at LFO, the cycle speed is adjusted. It is linked with the [EFFECT AMOUNT] knob on the top panel when the SOURCE (5) is set at LFO.

The setting range is 0 to 127. The cycle becomes faster as the value increases.

10 Wah-Wah - FREQUENCY

Adjusts the central frequency. It is linked with the [EFFECT AMOUNT] knob on the top panel when the SOURCE (5) is set at MAN.

The setting range is 0 to 127. The frequency becomes higher as the value is increased.

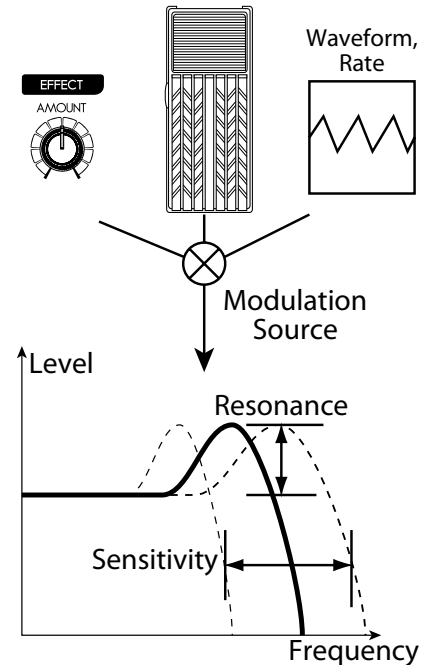

Ring Mod.

The Ring Modulator creates complex, metallic-like sounds by taking the sum and difference of the fundamental tone and a second “ring” frequency.

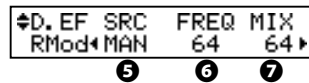
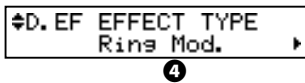

6

7

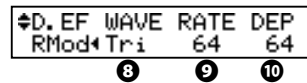

9

10

5 RING MODULATOR - SOURCE

Selects what to use to modulate the ring frequency.

MAN: Uses the following FREQ parameter, i. e. the [EFFECT AMOUNT] knob.

EXP: Modulates the ring frequency with the Expression Pedal.

LFO: Allows a cyclical modulation effect using the built-in LFO-Low Frequency Oscillator.

NOTE: The ring frequency changes by the note, i. d. the UPPER Part performance (or the performance of the allocated part if in the Extra Voices).

6 RING MODULATOR - FREQUENCY

Adjusts the central ring frequency. It is linked with the [EFFECT AMOUNT] knob on the top panel when the SOURCE (5) is set at MAN, EXP and NOTE.

The setting range is 0 to 127. The frequency becomes higher as the value increases.

7 RING MODULATOR - MIX

Adjusts the volume balance between the fundamental and effect sounds.

The setting range is 0 to 127. At 0, only the fundamental sound is heard. As the value is raised, the more effect is added. At 127, only the effect comes out.

8 RING MODULATOR - WAVEFORM

When the SOURCE (5) is set at LFO, the LFO waveform is set.

Tri: Triangle wave. The ring frequency number smoothly varies.

Sqr: Square wave. The ring sound suddenly changes to treble and also suddenly to bass.

Saw: Sawtooth wave. The ring sound repeatedly drops from treble to bass.

S&H: Sample & hold wave. The ring frequency changes randomly.

9 RING MODULATOR - RATE

When the SOURCE (5) is set at LFO, the frequency speed is adjusted. It is linked with the [EFFECT AMOUNT] knob on the top panel when the SOURCE (5) is set at LFO.

The setting range is 0 to 127. The cycle becomes faster as the value is raised.

10 RING MODULATOR - DEPTH

Adjusts the depth of the frequency change when the source is set at LFO or EXP.

The setting range is 0 to 127. The ring frequency becomes wider as the value is raised.

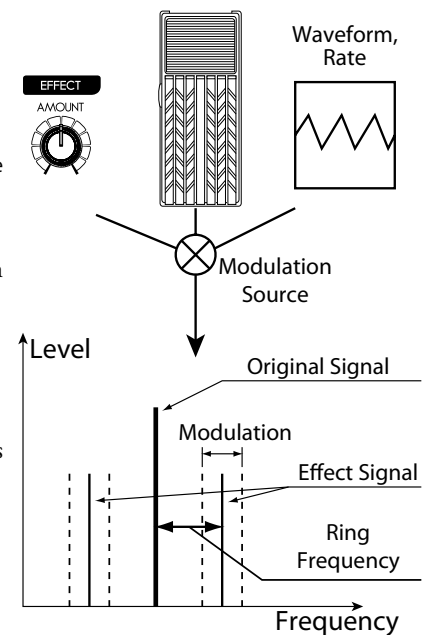

Phaser

This creates a sound with a shifting phase, adding a twisting effect to the sound..

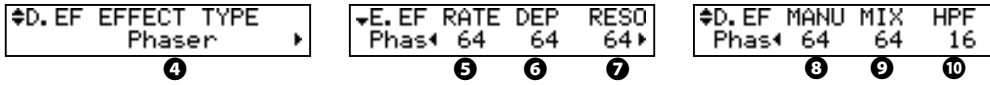

5 PHASER - RATE

Adjusts the frequency speed. It is linked with the [EFFECT AMOUNT] knob. The setting range is 0 to 127. The cycle becomes faster as the value increases.

6 PHASER - DEPTH

Adjusts the depth of modulation. The setting range is 0 to 127. The modulation becomes deeper as the value increases.

7 PHASER - RESONANCE

Adjusts the resonance (feed-back) amount. The setting range is 0 to 127. The resonance becomes greater as the value increases. At higher values, the sound is modulated beyond normal recognition.

8 PHASER - MANUAL

Sets the middle frequency of the phase effect. The setting range is 0 to 127. The frequency becomes higher as the value increases.

9 PHASER - MIX

Adjusts the volume balance between the “dry” and the effect sound. The setting range is 0 to 127. At 0, only “dry” is heard. The effect level becomes greater as the value increases. At 127 the ratio between the “dry” and the effect sounds becomes 1:1.

10 PHASER - HPF

Controls the frequency range of the effect. The setting range is 0 to 127. At 0 the effect is added to all frequencies. The effect is added to the higher frequencies as the value increases.

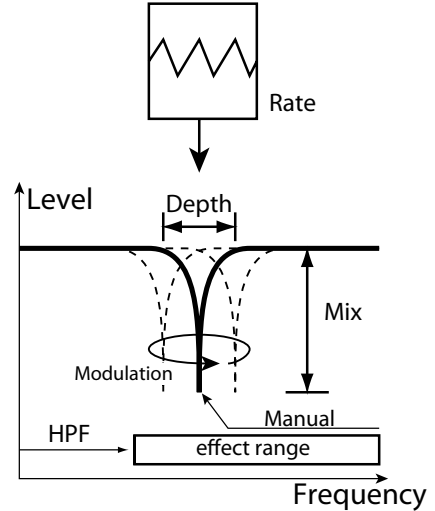

Flanger

This is the sweeping “Jet Airplane” sound adjustable from a mild shimmer to a deep “swoosh”.

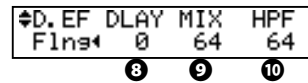
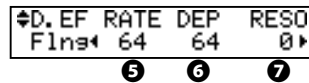
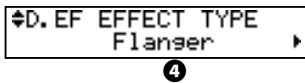

⑤ FLANGER - RATE

Adjusts the modulation speed. It is linked with the [EFFECT AMOUNT] knob on the top panel.

The setting range is 0 to 127. The cycle becomes faster as the value increases.

⑥ FLANGER - DEPTH

Adjusts the depth of modulation.

The setting range is 0 to 127. The modulation becomes deeper as the value increases.

⑦ FLANGER - RESONANCE

Adjusts the amount of resonance (feed-back).

The setting range is 0 to 127. The resonance becomes greater as the value increases. At higher values, the sound is modulated beyond normal recognition.

⑧ FLANGER - DELAY

Controls the delay of the effect sound.

The setting range is 0 to 127. The delay increases as the value is increased.

⑨ FLANGER - MIX

Adjusts the volume balance between the “dry” and the effect sound.

The setting range is 0 to 127. At 0, only the “dry” is heard. The effect level becomes greater as the value is increased. At 127 the ratio between the “dry” and the effect sounds becomes 1:1.

⑩ FLANGER - HPF

Controls the frequency range of the effect.

The setting range is 0 to 127. At 0 the effect is added to all frequencies. The effect is added to the higher frequencies as the value increases.

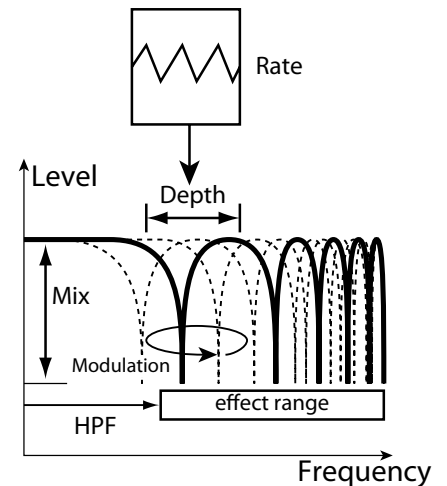

Chorus

This “Chorus” is NOT the same as Hammond’s proprietary “Chorus-Vibrato”. This effect is the familiar Chorus as heard widely on electric pianos, guitars, etc.

#D.	EF	EFFECT TYPE
4		Chorus

#D.	EF	RATE	DEP	RESO
5		64	64	0

#D.	EF	DLY	MIX	HPF	PH
8		0	64	64	3

5 CHORUS - RATE

Adjusts the speed of the cycle of the rising and falling effect pitch. It is linked with the [EFFECT AMOUNT] on the top panel.

The setting rate is 0 to 127. The cycle becomes faster as the value increases.

6 CHORUS - DEPTH

Adjusts the depth of modulation.

The setting range is 0 to 127. The modulation becomes deeper as the value increases.

7 CHORUS - RESONANCE

Adjusts the amount of resonance (feed-back).

The setting range is 0 to 127. The resonance becomes greater as the value increases. At higher values, the sound is modulated beyond normal recognition.

8 CHORUS - DELAY

Controls the delay of the effect sound.

The setting range is 0 to 127. The delay becomes greater as the value increases.

9 CHORUS - MIX

Adjusts the volume balance between the “dry” and the effect sound.

The setting range is 0 to 127. At 0, only the “dry” is heard. The effect level becomes greater as the value increases. At 127 the ratio between the “dry” and the effect sounds becomes 1:1.

10 CHORUS - HPF

Controls the frequency range of the effect.

The setting range is 0 to 127. At 0, the effect is added to all frequencies. The effect is added to the higher frequencies as the value increases.

11 CHORUS - PHASE

Selects the type of the chorus effect available:

“2” (normal) or “3” (rich) phase effect type.

NOTE: There is no phase parameter on the organ section. And it is fixed at “2”.

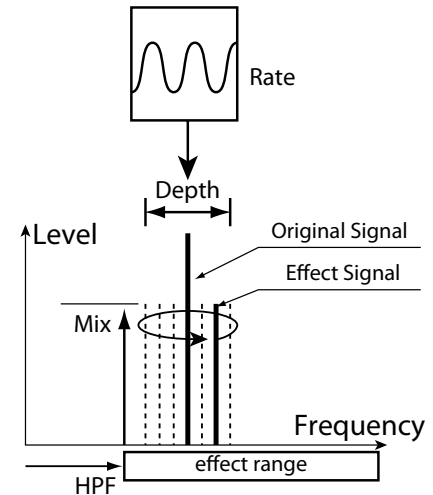

Delay

This is for adding echo effects.

◀D. EF EFFECT TYPE
Delay ▶

4

◀D. EF TYPE TIME F. B.
MONO 1000 50▶

5

6

7

◀D. EF MIX
64▶

8

5 DELAY - TYPE

Select the type of delay here.

MONO:

A simply delayed sound.

RtoL, LtoR:

The delay is alternated in the stereo field. At RtoL the delayed sound comes from the right, and at LtoR from the left. Your results may vary when used in a mono idiom, or through a Leslie Speaker.

6 DELAY - TIME

Adjusts the delay time. It is linked with the [EFFECT AMOUNT] on the top panel.

The setting range is 10 to 1000 ms.

7 DELAY - FEED-BACK

Sets the repetition amount of the effect sound.

The setting range is 0 to 127. The repetition becomes greater as the value is increased.

8 DELAY - MIX

Adjusts the volume balance between the “dry” and the effect sound.

The setting range is 0 to 127. At 0, only the “dry” is heard. The effect level becomes greater as the value is increased. At 64 the ratio between the “dry” and the effect sounds becomes 1:1. At 127 only the effect sound is heard.

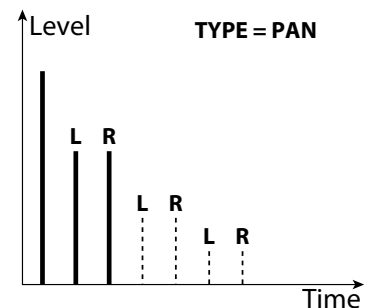
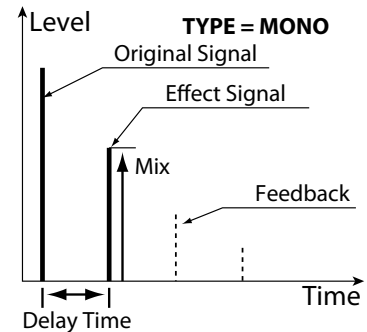

◆ EFFECTS OF THE EXTRA VOICE SECTION

OVERDRIVE

12 OVERDRIVE - SWITCH

Turns the Overdrive effect of Extra Voice section “ON/OFF”.

NOTE: While this parameter is “ON”, the stereo sound of “Stereo Grand” etc. becomes monaural.

13 OVERDRIVE - DRIVE

Controls the distortion amount. The distortion becomes greater as the value is increased.

There is no knob linked with this effect, different from the organ section, so the setting is possible only in this mode.

14 OVERDRIVE - EXPRESSION

15 OVERDRIVE - PREAMP

The functions of these parameters are the same as those of the organ section.

MULTI-EFFECTS

16 EFFECT TYPE

and the other effect parameters

The functions of these parameters are the same as those of the organ section.

NOTE: All the parameters in these modes are Patch Parameters. They are recorded into the Patch.

EQUALIZ (Equalizer)

In this mode, you adjust the settings for the Equalizer.

An Equalizer is used to adjust the tonal quality. The SK1/2's built-in Equalizer consists of 3 bands and a recreation of the unique "tone" control that was part of the vintage B-3. The Bass and Treble bands are handled by "shelf" equalizers, and the Mid band is handled by parametric control.

To locate this mode:

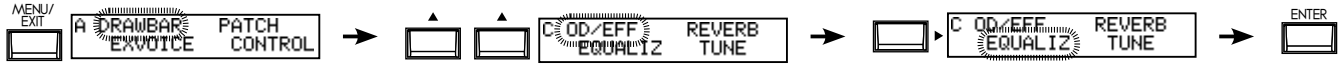

See "Function mode" (P. 68) for operation details.

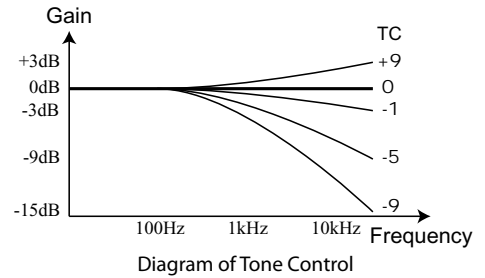
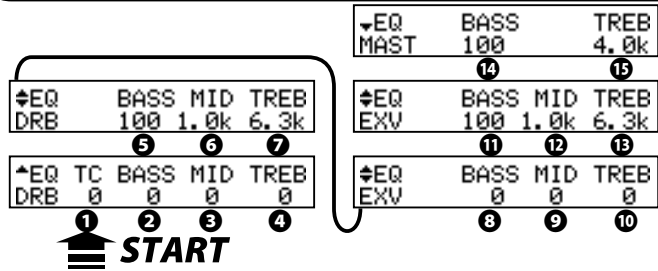

◆ ORGAN SECTION

1 TONE CONTROL (P)

This is a simulated original B-3 TONE CONTROL. Its response is unique, but its basic response is to gently cut the overall treble above 200Hz.

The setting range is -9 to +9, and it becomes neutral when set at "0". "-1" corresponds to the maximum of the original B-3 tone control, "-5", the middle, "-9", the minimum. The tone control found on the original B-3, was only available at "minus" settings, but here you are able to "plus" the settings as well.

◆ ORGAN SECTION, EXTRA VOICE SECTION

2, 8 GAIN - BASS (P)

3, 9 GAIN - MIDDLE (P)

4, 10 GAIN - TREBLE (P)

Adjusts the Boost/Cut of Bass, Mid-range and Treble respectively.

The setting range is -9 to +9. It is flat at 0.

5, 11 FREQUENCY - BASS (P)

6, 12 FREQUENCY - MIDDLE (P)

7, 13 FREQUENCY - TREBLE (P)

Adjusts the center frequency (MIDDLE) / turnover frequency (BASS, TREBLE) to be attenuated.

The setting range is 20Hz - 200Hz for BASS, 250Hz - 3.1kHz for MIDDLE, 4.0kHz - 8.0kHz for TREBLE.

❖ The sound may distort if gains are raised too high. Adjust accordingly.

◆ MASTER EQUALIZER

14 FREQUENCY - BASS (G)

15 FREQUENCY - TREBLE (G)

Adjusts the turnover frequency that will be attenuated.

NOTE: The parameter with (P) indicated is a patch parameter, and is recorded to each patch. (G) indicates "global parameter", which is recorded upon being set, and is common with each patch.

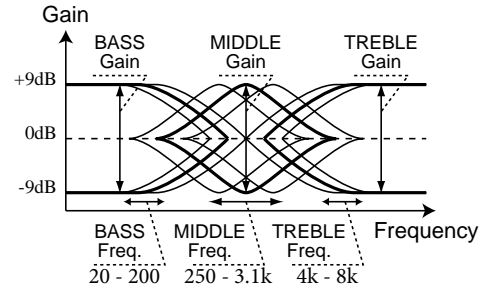

tips THE EFFECTIVE USE OF THE MIDDLE FREQUENCY

The frequency response of the horn rotor in the Leslie speaker is not flat. It has a peak from 1kHz to 3kHz. This peak is effective in "cutting through" any ensemble playing.

If you use this organ through line out without a Leslie speaker, you can duplicate effect by setting the FREQUENCY- MIDDLE to approximately 2kHz, and the GAIN - MIDDLE to "+".

tips TURNOVER FREQUENCY

The MIDDLE of this equalizer controls a point of frequency. This is called center frequency. The BASS (or TREBLE) controls lower (or higher) than specified frequency. This is called turnover frequency.

tips PATCH PARAMETERS

The equalizer is designed to be a patch parameter to be actively utilized as a part of sound making parameter.

Use the Master Equalizer for tonal compensation to match the performance stage (P. 27).

In this mode, you set the Reverb effect.

Reverb is common with the Organ and Extra Voice sections, the single reverb control section affects both.

To locate this mode:

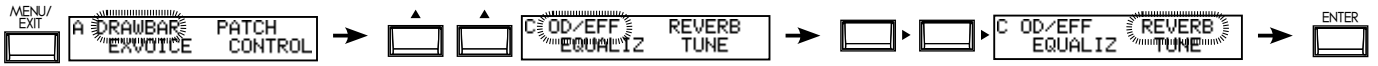

or, keep pressing the [REVERB ON] button for a few seconds.

See “Function mode” (P. 68) for operation details.

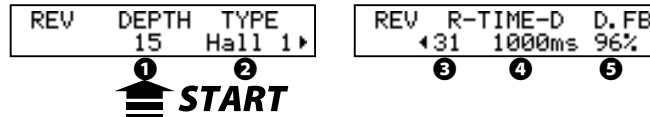

❶ DEPTH

This sets the depth (volume) of the Reverb Effect.

The setting range is 0 to 127. This parameter is linked with the [REVERB DEPTH] knob on the top panel.

❷ TYPE

This sets the types of Reverb Effect.

- Room 1:** Small room
- Room 2:** Large room
- Live:** Ambient room
- Hall 1:** Large Hall
- Hall 2:** Small Hall
- Church:** Church
- Plate:** Iron-plate Reverb
- Spring:** Spring Reverb
- Delay:** Delay
- PanDly:** Panning Delay
- RevDly:** Reverb + Delay

❸ REVERB TIME

When the Type (#2) is set at Room 1 to Spring, The decay of the Reverb is attenuated.

The setting range is 0 to 127. The decay becomes greater as the value is increased.

❹ DELAY TIME

When the Type (#2) is set at Delay, PanDly, RevDly, this sets the delay time.

The setting range is 4.7 to 2000ms. The delay becomes longer as the number value is increased.

NOTE: You can set the delay time with the foot switch. (P. 78 #2)

❺ DELAY FEEDBACK

When the Type (#2) is at Delay, PanDly, RevDly, it sets the amount of Feedback (How many times the sound repeats.)

The setting range is 0 to 96%. The repetition becomes greater as the value is increased.

NOTE: Type (#2) is a micro-parameter. When you change the type, each reverb parameter (except #1) is automatically set to the recommend value.

NOTE: All the parameters in these modes are Patch Parameters. They are recorded into the Patch.

TUNE

In this mode, the entire keyboard is tuned.

To locate this mode:

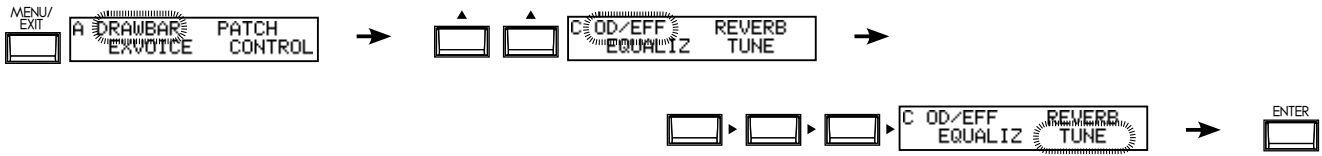

See “Function mode” (P. 68) for operation details.

TUNE MASTER
A=440



◆ MASTER TUNE

① MASTER TUNE

This is for tuning the entire keyboard.

The setting range is A = 430 to 450 Hz.

NOTE: The parameter of this mode is a global parameter. It is recorded when it is set, and is common for each patch.

In this mode, you can go back totally or partially to the factory default settings.

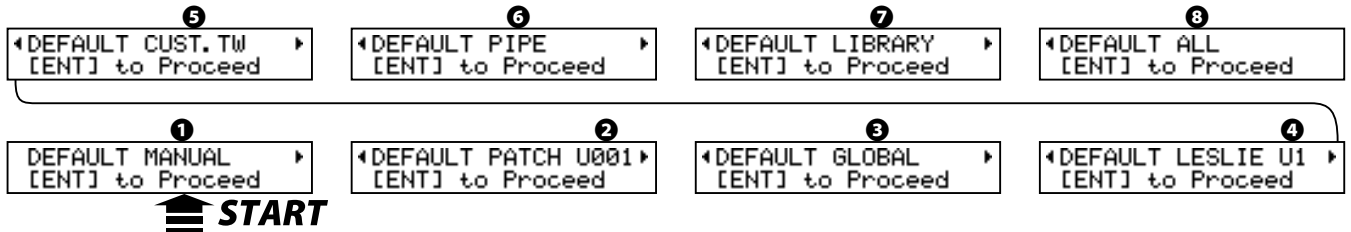
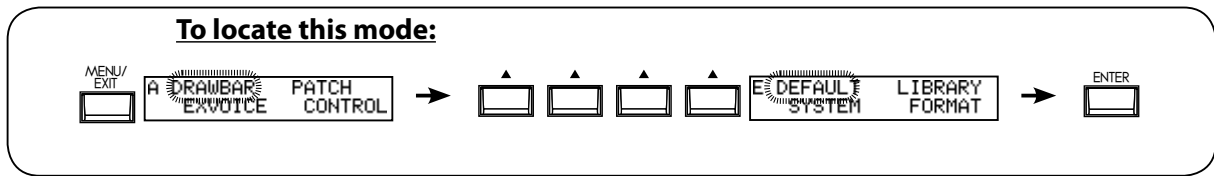

To initialize each parameter, select the parameter you want to initialize with the [◀][▶] button and press the [ENTER] button.

1 MANUAL

This is for initializing the contents of the [MANUAL] button.

Used to create a “clean slate” for new Patch settings.

2 PATCH

This is for initializing the User Patch contents (from Preset Patch with same patch number). Select the Patch you want to initialize with the [VALUE] knob. The selecting range is U001 to U100 and ALL (All user patches).

3 GLOBAL

This is for initializing the Global Parameters such as the Master Tune or assignment of the Foot Switch.

4 LESLIE

This is for initializing the contents of all internal Leslie cabinets. Select the cabinet you want to initialize with the [VALUE] knob. The selecting range is U1 to U8 and ALL (All User cabinets).

5 CUSTOM TONE-WHEELS

This is for initializing the contents of all custom Tone-Wheels.

6 PIPE

This is for initializing the Pipe parameters.

7 LIBRARY

This is for deleting all the tone library contents and rewriting to the default contents.

8 ALL

This is for defaulting all parameters of this keyboard.

If any unstable condition occurs on this keyboard system, defaulting “all” will usually clear the problem.

NOTE: You can also totally initialize your keyboard by switching the power ON while pressing and holding the [RECORD] button.

SYSTEM

In this mode, the audio output mode and the System information of the SK1/SK2 is displayed.

To locate this mode:

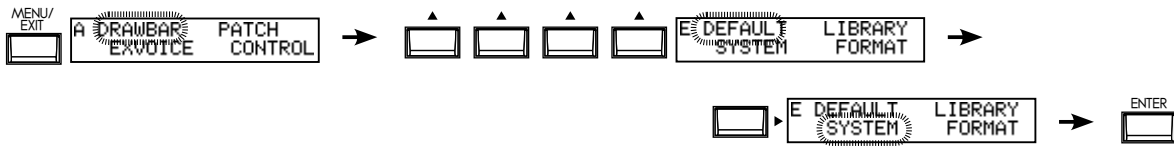

See "Function mode" (P. 68) for operation details.

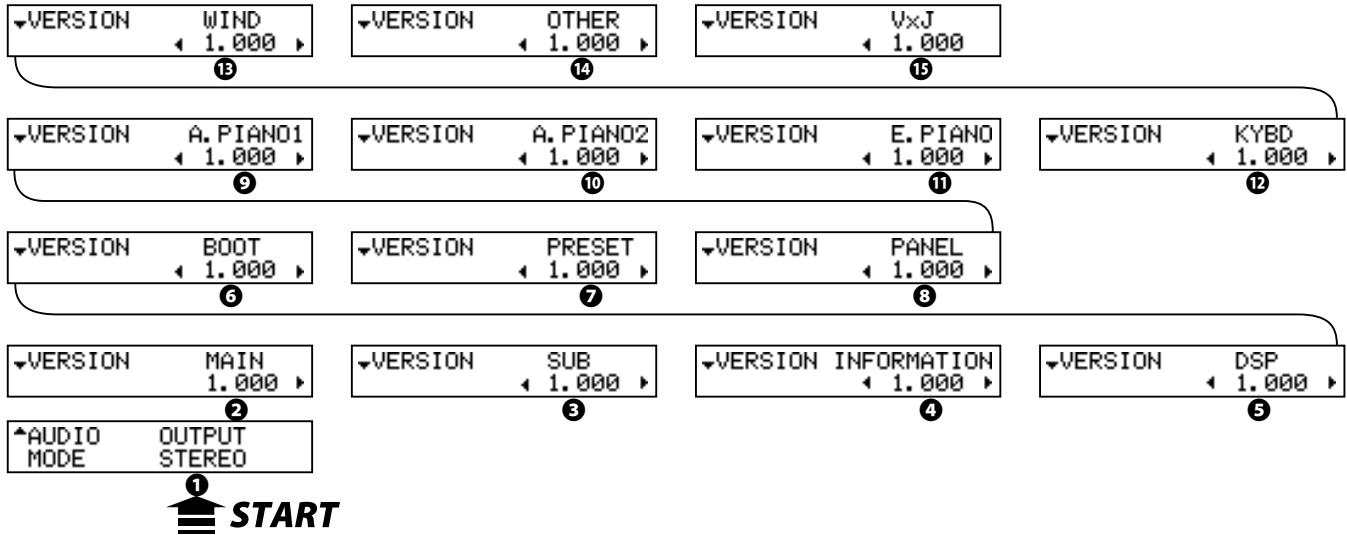

1 AUDIO MODE - OUTPUT

Sets the audio mode of output jacks.

STEREO

Use this if it is stereo connection. You can get the maximum stereophonic sound effects.

MONO

Use this if it is mono connection. Though it makes no stereophonic sound effects, it avoids "drop out" by sounding opposite channel.

2 VERSION - MAIN PROGRAM

3 VERSION - SUB-PROGRAM

4 VERSION - VOICE INFORMATION

5 VERSION - D. S. P.

6 VERSION - BOOTSTRAP PROGRAM

7 VERSION - FACTORY PRESET

8 VERSION - CONTROL PANEL

9 VERSION - EXV (A. Piano 1)

10 VERSION - EXV (A. Piano 2)

11 VERSION - EXV (E. Piano)

12 VERSION - EXV (Keyboard)

13 VERSION - EXV (Wind)

14 VERSION - EXV (Others)

15 VERSION - EXV (VxJ)

These are display only and not intended for System update use.

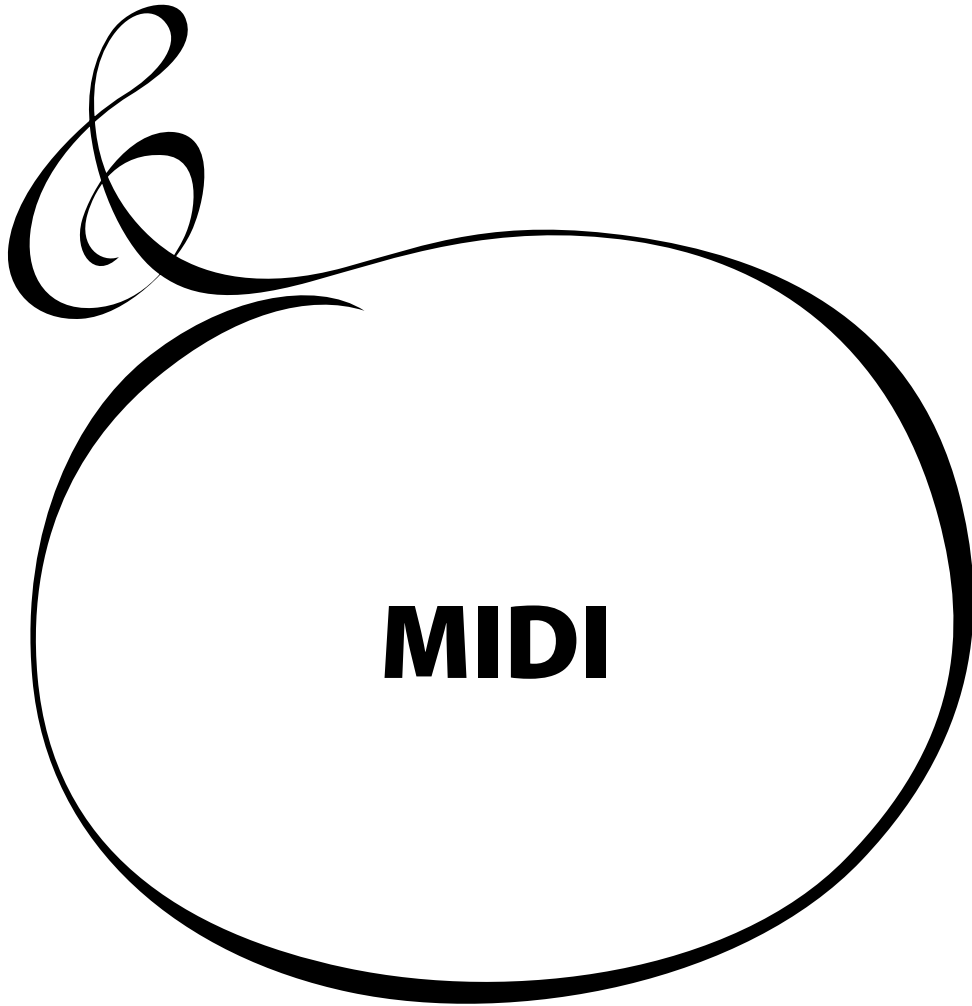

WHAT IS “MIDI”?

MIDI is an abbreviation of ‘Musical Instrument Digital Interface’.

MIDI is the musical instrument industry standard for exchanging performance information between electronic musical instruments and a sequencer, effects, lighting, and sound reinforcement gear, etc.

The MIDI standard allows instruments made by different manufacturers to effectively communicate with each other.

Many types of data can be transmitted and received, including all performance information, settings of parameters, and global commands.

MIDI JACKS ON THIS KEYBOARD

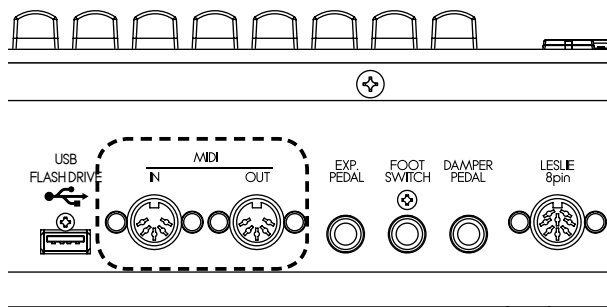

MIDI OUT JACK

This is for sending performance information.

To an external MIDI sound module from this keyboard or to record performances and controls to an external sequencer.

MIDI IN JACK

This jack is used for playing this keyboard from external MIDI equipment.

WHAT THE MIDI CAN DO ON YOUR KEYBOARD

On this keyboard, the MIDI terminals are intended to do the following:

- ♦ use the MIDI keyboard to expand the number of manual keyboards.
- ♦ control an external sound generator such as a synthesizer or sampler.
- ♦ record/playback the performance on an external sequencer or computer.

For easily making these settings, this keyboard is equipped with “MIDI Templates”.

MIDI CHANNEL

MIDI has 16 “Channels”. Information divided into 16 channels can be transmitted through one MIDI cable.

The channel must match between the sender and the receiver. If not, the machines can not “hear” what the other “says”.

MAIN MIDI MESSAGE

The MIDI information is grouped into a channel message per each of the 16 channels and a system message for all channels. There are more details in the MIDI IMPLEMENTATION CHART.

CHANNEL MESSAGE

◆NOTE ON

This data tells: which key (Note Number) is played, at what speed (Velocity) and the strike/release (Note On/Off).

◆PROGRAM CHANGE

Control Channel:

Switches the internal patches of this keyboard.

External Zone Channel:

Switches the external MIDI equipment's patches.

◆CONTROL CHANGE

The messages are transmitted (sent or received) in accordance with the motion of select controls on the top panel, any foot or auxiliary pedals, or any MIDI controller information.

SYSTEM MESSAGE

◆SYSTEM EXCLUSIVE MESSAGE

This message is for transmitting the particular data between compatible equipment of the same model or same make.

This keyboard can do a memory dump (= sending the total information compliment onboard) and recording them to an external sequencer.

MIDI STRUCTURE

This keyboard has “Keyboard Channels” to transmit playing information of the keyboards and “External Zone Channels” to control external MIDI equipment on the keyboards.

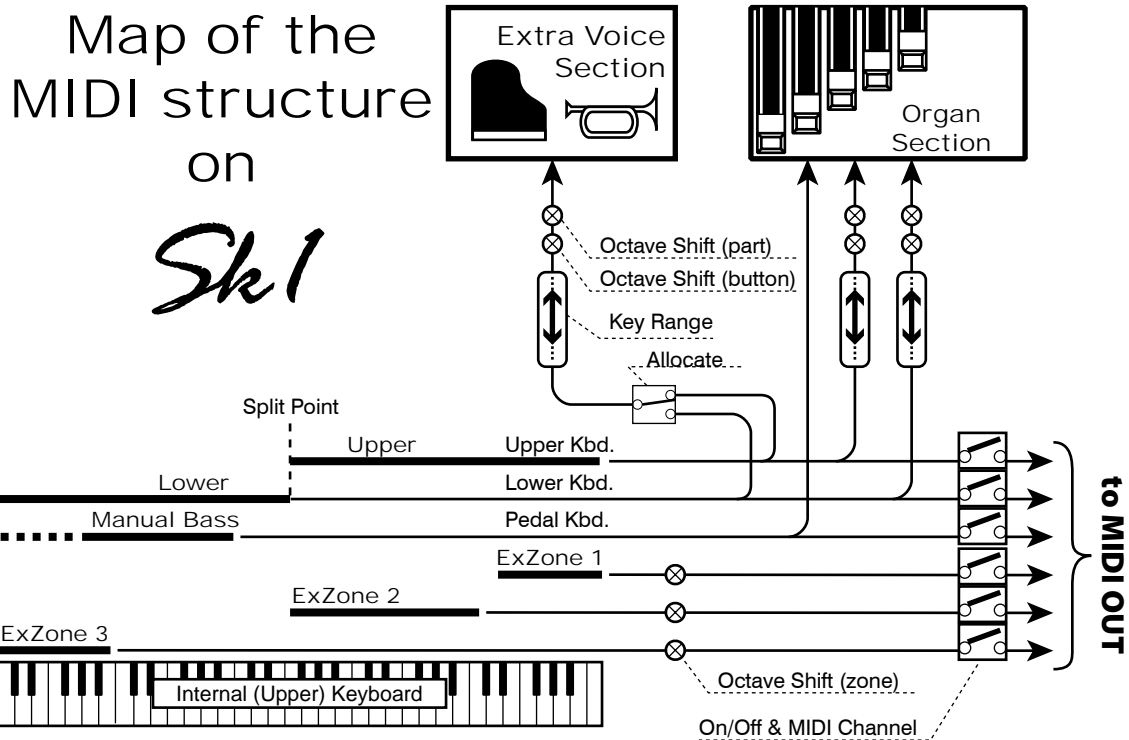

◆ KEYBOARD CHANNELS

The Keyboard channels transmit the playing information of the Upper, Lower and Pedal parts. These are used to exchange playing information with an external sequencer.

Through the Upper channel, besides the keyboard information, that of each controller is transmitted.

◆ EXTERNAL ZONE CHANNELS

The External Zone channels are for using this keyboard as a simple master keyboard to control the external MIDI equipment. These are Patch parameters, and it is possible to make different settings to each Patch.

There are 3 external zones in total. Each can be allocated to the desired keyboards (for example, 3 zones for the Upper keyboard and 1 each for the U/L/P keyboards).

◆ EXPANDED KEYBOARDS

When the MIDI keyboard is expanded for Lower and Pedal parts, they behave as if the built-in keyboard on the keyboard, and, not only sounds the built-in sound generator, but also are transmitted through the MIDI OUT jack to the keyboard channels as well as transmitted to the external zones.

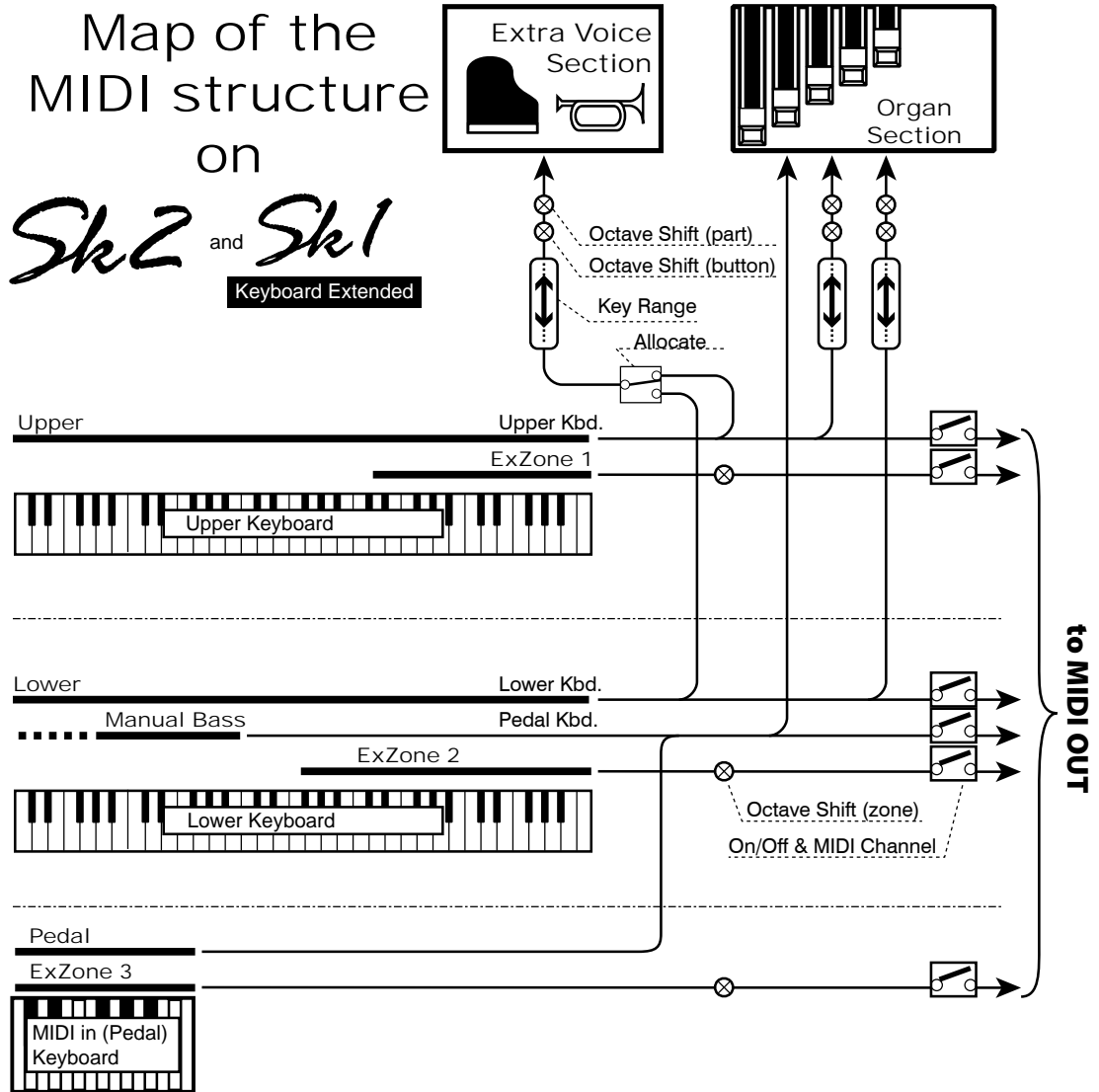

USING AN EXTERNAL SEQUENCER

This is to record/playback the performance by connecting an external sequencer or computer to this keyboard.

◆ Recording a performance to an external sequencer

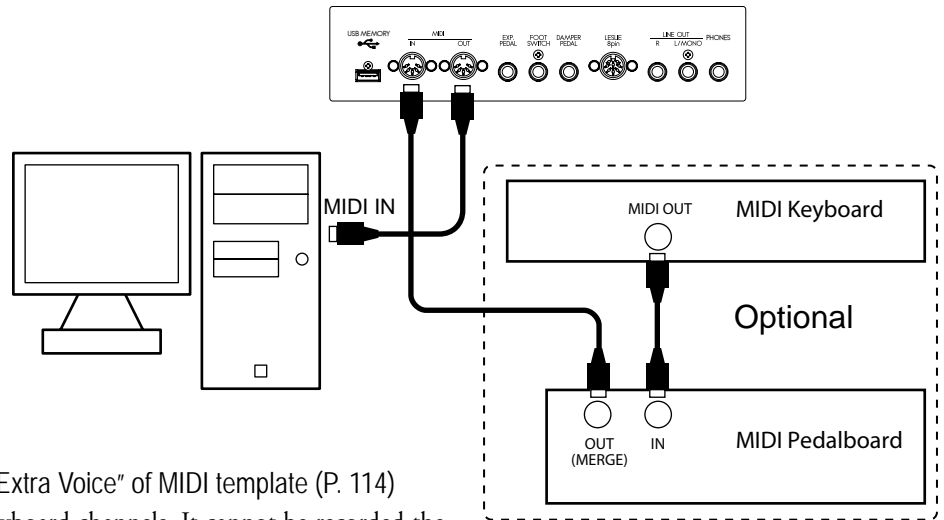

1. Connect as illustrated above.
2. Call the others than the "Use Ex. or Extra Voice" of MIDI template (P. 114)
The performance can be recorded by Keyboard channels. It cannot be recorded the control of the External Zones in this hook-up*1.
3. Set both the keyboard channel and the control channel.
Set the MIDI channel of this keyboard to that of the external sequencer.
4. Start recording on the external sequencer.
5. If necessary, send the memory dump.
6. Start playing.

*1 To record the control of External Zones, addition of above illustration, connect MIDI IN of controlled MIDI equipment to MIDI OUT of external sequencer, and set Echo ON the external sequencer.
When the playback, connect the MIDI OUT of external sequencer to MIDI IN of controlled MIDI equipment instead of this keyboard.

◆ Sequencer playback

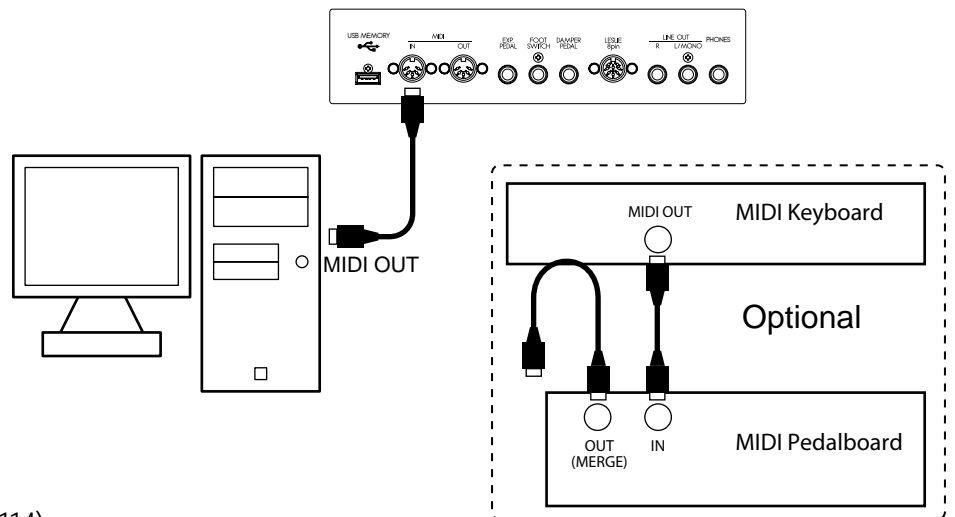

1. Connect as illustrated.
2. Call the MIDI template "Basic". (P. 114)
3. Set both the keyboard channel and the control channel.
Set the MIDI channel of this keyboard at that of the external sequencer.
4. Start playing on the external sequencer.

You can control an external MIDI sound module with the built-in keyboard and the expanded MIDI keyboard.

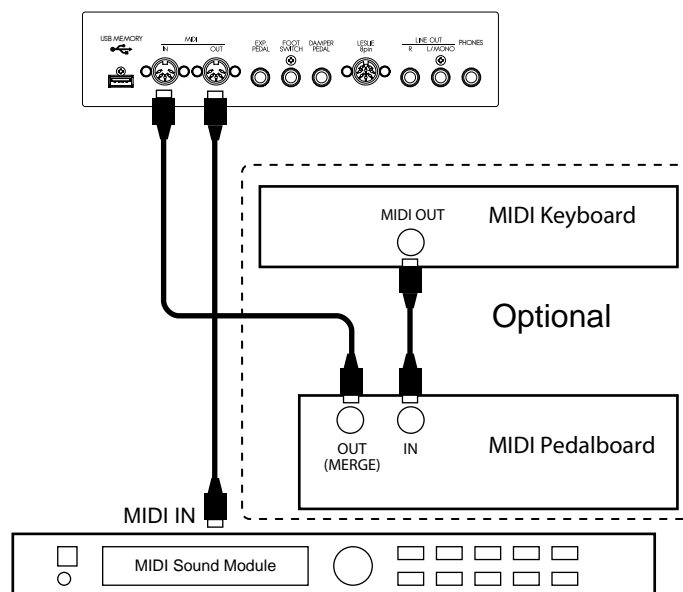

1. Connect as illustrated.

Connect the MIDI OUT of this organ to the MIDI IN of the MIDI sound module.

2. Call the MIDI template "Use Ex. xxx". (P. 114)

By this, the External Zone performance is sent from the MIDI OUT instead of Keyboard channels.

Use different MIDI templates, depending whether the keyboard is expanded or not.

3. Set each zone, and, if necessary, record to the patches.

See the next paragraph "ZONES" for the setting details.

tips WHY USING EXTERNAL ZONES

You can control the MIDI equipment by using Keyboard channels (easier) sure, but it makes some problem. Probably the program number is different between this keyboard and MIDI equipment that you wish to use. About octave, velocity sensitivity, and so on?

The External Zone is a solution. It has a program number, octave, velocity sensitivity and so on by each Patch. When a Patch is called, various messages for MIDI equipment will sent automatically.

ZONES

To control external MIDI equipment, ranges on the keyboard of this instrument are assigned. They are called "External Zones".

The range of the built-in sound engine on this keyboard (called "Internal Zone") is set at the same time. You can use each separately on a single manual keyboard.

Each MIDI keyboard connected to the MIDI IN jack can control the external MIDI equipment with the external zone.

To locate this mode:

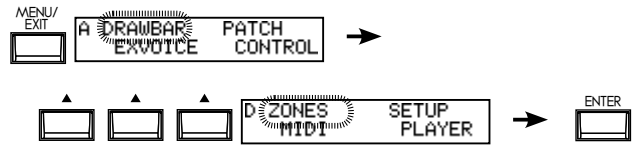

See "Function mode" (P. 68) for operation details.

↔XZ3 SWITCH CHANNEL
CHAN OFF 3 ▶

↔XZ3 ALLOC LO--HI
KYBD PEDAL 1C 6C ▶

↔XZ3 M-BNK-L PROG
PROG 0 0 1 ▶

↔XZ3 OCT VOL PAN VEL
NOTE +0 100 -C- 1 ▶

↔XZ2 SWITCH CHANNEL
CHAN OFF 2 ▶

↔XZ2 ALLOC LO--HI
KYBD LOWER 1C 6C ▶

↔XZ2 M-BNK-L PROG
PROG 0 0 1 ▶

↔XZ2 OCT VOL PAN VEL
NOTE +0 100 -C- 1 ▶

↔XZ1 SWITCH CHANNEL
CHAN OFF 1 ▶

↔XZ1 ALLOC LO--HI
KYBD UPPER 1C 6C ▶

↔XZ1 M-BNK-L PROG
PROG 0 0 1 ▶

↔XZ1 OCT VOL PAN VEL
NOTE +0 100 -C- 1 ▶

↔INT MAN. BASS SPLIT
KYBD LOW 2B 2B ▶

↔INT UPPER LOWER
OCTAVE +0 S+0 R+0 ▶

↔INT MAN. BASS LtoP
KYBD LOW 2B 2B ▶

↔INT UPPER LOWER
OCTAVE +0 +0 ▶

SK1's **START**

SK2's **START**

◆ WHAT IS DISPLAYED ON THE UPPER LEFT?

On the upper left of the Zone mode, the Zone to be operated now is displayed.

- INT: Internal zone
- XZn: External zone (#n)

◆ INTERNAL ZONE

① MANUAL BASS - MODE

This is for setting the how the Manual Bass (P. 33) works.
LOW: Sounds on lowest note if a chord is played.
CHRD: Sounds suitable bass note if a chord is played on Lower part.
POLY: Sounds the chord if a chord played.

② MANUAL BASS - LIMIT

Sets the upper limit note for the Manual Bass function.

③ SPLIT POINT (on SK1 only)

Sets the upper limit note for the Lower part when using the split function (P. 33).

③ LOWER to PEDAL (on SK2 only)

Sets the upper limit note for the 'Lower to Pedal' coupler (P. 34).

④ OCTAVE - UPPER

Sets the octave of the Upper part. It is linked with the [OCTAVE UP], [OCTAVE DOWN] buttons on the top panel.

⑤ OCTAVE - LOWER on SPLIT (on SK1 only)

This is for setting the octave of the Lower part. This parameter works on splitted Lower division of internal keyboard.

⑥ OCTAVE - LOWER on REAL

This is for setting the octave of the Lower part. This parameter works on expanded Lower keyboard (SK1) and Lower keyboard (SK2).

[OCTAVE LOWER] button on the top panel adjusts #5 or #6 with select automatically.

◆ EXTERNAL ZONE

⑥ SWITCH

Sets whether or not to send the MIDI message in this zone.

⑦ MIDI CHANNEL

Sets the MIDI send channel 1 to 16 of this zone.

⑧ KEYBOARD ALLOCATE

Sets which keyboard to allocate this zone.

Set to the UPPER if it is only the SK1.

If on SK2 or there is an expanded keyboard, you can control the external zone using the Lower keyboard or the Pedalboard. In this time, set at LOWER or PEDAL.

Set at OFF if an external synthesizer is connected, to change the Program or volume only, and no sending the note (playing) messages.

⑨ ZONE - LOW

⑩ ZONE - HIGH

Sets the keyboard range for playing this zone.

Set the lower limit with LO and the upper limit with HI.

NOTE: 9 and 10 can also be set by pressing the [RECORD] button with play the desired note on the keyboard.

⑪ PROGRAM - BANK MSB

⑫ PROGRAM - BANK LSB

⑬ PROGRAM - PROGRAM CHANGE

Sets Bank Select and the Program Change to send to this zone.

Generally, switching the tone of an external synthesizer or sampler is set by changing the Bank Select and the Program Change. Please consult the owners manual of your MIDI equipment to obtain the proper settings for Bank and Program change.

You can select the Bank MSB and LSB at 0 to 127, the Program Change at 1 to 128.

↓XZ3 MIN-MAX CC# EXP.◀ 40 127 11:EXP▶	↓XZ3 DAMPER MSGS◀ ON
↕XZ2 MIN-MAX CC# EXP.◀ 40 127 11:EXP▶	↕XZ2 DAMPER MSGS◀ ON
↕XZ1 MIN-MAX CC# EXP.◀ 40 127 11:EXP▶	↕XZ1 DAMPER MSGS◀ ON
19 20 21	22

14 NOTE - OCTAVE

Sets octave shift of this zone. If an external synthesizer sound in a different octave from that you desire, adjust this parameter.

The setting range is -2 to +2.

15 NOTE - VOLUME

Sets the volume (Control Change #7) of this zone. However, if CC# (20) is at "VOL", this setting value is null.

16 NOTE - PAN

Sets the Pan of this zone (Control Change #10).

17 NOTE - VELOCITY

Sets the character of the velocity to send to this zone.

The setting range is OF and 1 to 4. At OF, the velocity is fixed at 100. The "touch" (velocity response) of the keyboard progresses from 1 (heavier) through 4 (lighter).

18 EXPRESSION - MINIMUM**19 EXPRESSION - MAXIMUM**

Sets the range to "compress" the expression information to send to this zone.

On the electronic organ, even if the expression pedal is fully returned, sound does not perfectly silenced. If a GM sound generator is used, no sound comes out. This is a parameter to balance it.

The setting range is MIN at 0 to 63, MAX at 64 to 127.

20 EXPRESSION - CONTROL NUMBER

Sets the MIDI control change number (CC#) of the expression pedal.

The way of controlling volume differs type by type of the MIDI equipment to be connected. This parameter is for setting a proper number to control the volume of the connected MIDI equipment.

You can select 7: VOL, 11: EXP.

21 MESSAGE - DAMPER

Sets whether to send the damper information to this zone.

NOTE: The parameters in these modes are patch parameters, and are recorded to the patch.

PANIC FUNCTION AND PARAMETER RE-LOAD

If a problem occurs to the MIDI system, it may be caused by a cypher. When this keyboard and an external MIDI equipment is connected, such a problem could happen due to the difference between the setting contents of both equipment.

In such a case, touch both [▲], [▼] buttons. Both the "All Note Off" and "Reset All Controllers" are sent to the MIDI channels of all external zones (Panic Function), then the settings of all external zones are reloaded (sent again).

In this mode, you make the basic MIDI settings and the memory dump operation.

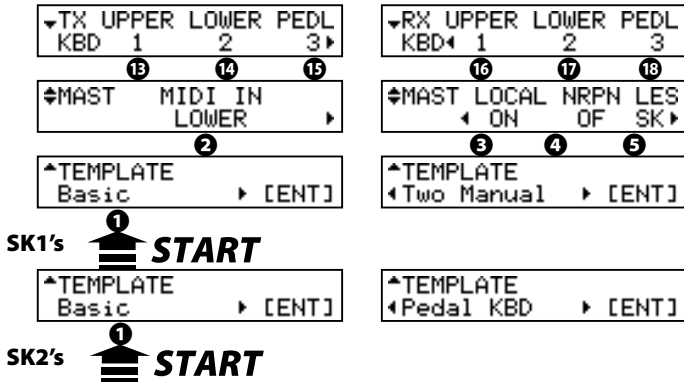

◆ MIDI TEMPLATE

① MIDI TEMPLATE

This mode allows common MIDI setups to be recalled.

By selecting the use with the [◀][▶] buttons and pressing the [ENTER] button, the typical settings are called.

The SK1 and the SK2 have different functions, so the MIDI templates are also different. See "MIDI TEMPLATE" in the Appendix (P. 138) for details of each MIDI template.

◆ MASTER

② MIDI IN

This is for switching the MIDI jack function.

LOWER

The received MIDI data sounds the LOWER part and are re-sent to the LOWER channel (#14) of the MIDI OUT jack, regardless of the settings of the MIDI channel.

PEDAL

The received MIDI data sounds the PEDAL part and are re-sent to the PEDAL channel (#15), regardless of the setting of the settings of the MIDI channel.

LOW + PED

The received MIDI data sounds the LOWER and the PEDAL parts in accordance with the MIDI channel settings and are re-sent to the LOWER (#14) and the PEDAL (#15) parts.

SEQUENCE

The received MIDI data sounds the UPPER, LOWER and PEDAL parts in accordance with the MIDI channel settings. They are not re-sent.

EXVOICE

The received MIDI data sounds the Extra Voice section regardless of the MIDI channel settings. They are not re-sent.

UPPER

The received MIDI data sounds the UPPER part and are re-sent to the UPPER channel (#13) of the MIDI OUT jack, regardless of the settings of the MIDI channel.

UPP + PED

The received MIDI data sounds the UPPER and the PEDAL parts in accordance with the MIDI channel settings and are re-sent to the UPPER (#14) and the PEDAL (#15) parts.

To locate this mode:

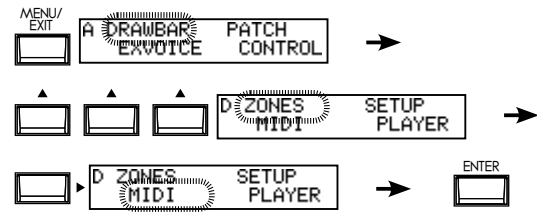

See "Function mode" (P. 68) for operation details.

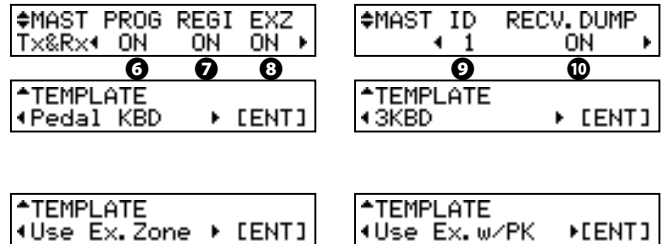

③ LOCAL

This switches the Local Control ON/OFF.

When switched ON, the keyboard(s) and the internal sound engine are connected. When OFF, the keyboard(s) and the sound engine are disconnected no sound is played.

You can use this keyboard as two different equipment; the MIDI keyboard and the sound module at the same time.

④ NRPN

This switches the NRPN (Non-Registered Parameter Number) ON/OFF.

On this keyboard it is used for transmitting the messages such as the Drawbar Fold Back or the Leslie ON. The NRPN is transmitted through the UPPER channel.

When switched ON, it is transmitted. When OFF, not transmitted.

⑤ LESLIE

This is for controlling how to send Leslie Parameters. The Leslie Parameters sent on UPPER Channel.

SK:

The Leslie Parameters will be sent out on this keyboard original NRPN address and data.

21:

The Leslie Parameters will be sent out for Leslie 21 series NRPN address and data.

When the Cabinet Number is selected (i.e. by Patch), the parameters are sent out also.

NOTE: This parameter will change automatically when the Leslie speaker is connected / disconnected.

⑥ PROGRAM CHANGE

This switches the transmission of the program change ON/OFF. When ON, transmitted. When OFF, not transmitted.

⑦ DRAWBAR REGISTRATION

This switches the transmission of the Drawbar registration ON/OFF. When ON, transmitted. When OFF, not transmitted.

⑧ EXTERNAL ZONE

This switches the transmission of the external zones as a whole ON/OFF. When ON, transmitted. When OFF, not transmitted.

◀MAST TEMPORARY DUMP
 ◀[ENT] to Send▶

11

▲TEMPLATE
 ◀Use Ex. Zone ▶ [ENT]

◀MAST ALL DUMP
 ◀[ENT] to Send▶

12

▲TEMPLATE
 ◀Use Ex. w/2Man▶[ENT]

▲TEMPLATE
 ◀Extra Voice [ENT]

▲TEMPLATE
 ◀Use Ex. w/PK ▶[ENT]

▲TEMPLATE
 ◀Use Ex. w/3KBD▶[ENT]

▲TEMPLATE
 ◀Extra Voice [ENT]

9 DEVICE ID

This sets the Device ID when transmitting the system exclusive messages such as the Memory Dump (#11, 12). For example, the receiving is neglected, when the Device ID does not match, even if the messages are the same.

10 RECEIVE DUMP

This switches whether to receive the Memory Dump or not ON/OFF.

On this keyboard the total onboard memory can be transmitted as a Memory Dump, as system exclusive messages. If you do not want the contents of this keyboard be changed by sequencer play, set this to OFF.

When ON, transmitted. When OFF, not transmitted.

11 TEMPORARY DUMP

Sends the Memory Dump.

When you press the [ENTER] button in this mode, the Temporary (the present settings) are sent as a whole from the MIDI OUT jack.

If you record the Temporary by doing this before you record your performance to the external sequencer, you can avoid the setting mismatching when you play it back later.

12 ALL DUMP

Sends the Memory Dump.

If you press the [ENTER] button in this mode, all the settings except the sound library contents are sent out of the MIDI OUT jack.

◆ KEYBOARD CHANNELS

Sets the MIDI channel to transmit at each part. The setting range is 1 to 16 and OF. At OF there is no transmission.

13 TX UPPER

Sets the MIDI channel for sending the UPPER part playing information, the control information of this organ and that of the Leslie speaker.

14 TX LOWER

Sets the MIDI channel for sending the LOWER part playing information.

15 TX PEDAL

Sets the MIDI channel for sending the PEDAL part playing information.

16 RX UPPER

Sets the MIDI channel for receiving the UPPER part playing information, the control information of this organ and that of the Leslie speaker.

17 RX LOWER

Sets the MIDI channel for receiving the LOWER part playing information.

18 RX PEDAL

Sets the MIDI channel for receiving the PEDAL part playing information.

❖ *To avoid confusion of MIDI signals, set each MIDI channel including the external zones (P. 112) to different numbers.*

NOTE: The settings in this mode are not recorded to the patches. They are recorded upon setting, and are common at all patches.

tips TEMPORARY DUMP CONTENTS

The patch parameters, global parameters and system parameters of the Temporary (= the present setting values) are transmitted.

The contents of each patch or that of the Leslie Cabinet are not transmitted. Use 'All Dump' or a USB flash drive for saving them.

tips TO SAVE ALL

All the setting values of this organ are transmitted by 'All Dump', but the contents of the Extra Voice section sound library are not transmitted, because the data are enormous large.

Use the USB flash drive to save all settings including the sound library.



SAVE YOUR SETUP

A USB memory connector is built in on this instrument. You can save the setting of each Parameter as a file to it. The USB memory can be used for the music player or as a sound library.

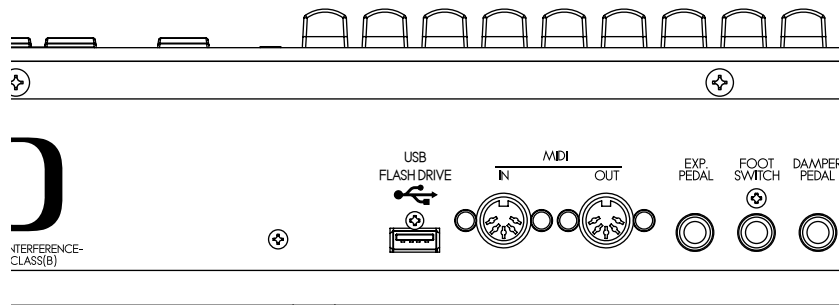

WHAT YOU CAN DO WITH THE USB FLASH DRIVE

- ♦ Saving / Restoring the set-ups of this keyboard. Unlike the memory dump, it is possible to save all data including the sound library.
- ♦ If you use the music player to playback audio data of WAVs (44.1 kHz 16 bit) and MP3 (44.1 kHz, 128 kbps), you can enjoy playing the keyboard with the accompaniment of the audio data.
- ♦ Load the exclusive sound library.
- ♦ the capacity of 1 file is 32K bytes (only set-ups), the maximum including the sound library is 32M bytes.
- ♦ 1 USB flash drive can save up to 99 set-up files.

ABOUT USB FLASH DRIVE

USABLE USB FLASH DRIVE

Consult our web site about compatible USB flash drives.

in Europe: <http://www.hammond.eu>

in The US: <http://www.hammondorganco.com>

USB MEMORY CONNECTOR

1. Insert the USB flash drive facing the correct direction, matching the upper side of it to that of this keyboard.
2. Do not remove the USB flash drive or switch OFF the power while accessing data (= while the "Please wait." is displayed). The data may be damaged.

FOLDER STRUCTURE

When the USB flash drive is inserted to this organ, the following folders are automatically created on the drive.

1. "HAMMOND" - "SK" in the root folder.
2. "SETUP", "AUDIO", "LIB", "SYSTEM" "PATCH" below it

SETUP

The setup file is saved here.

AUDIO

Place the audio file to playback with the music player.

LIB

Place the exclusive library file here.

SYSTEM

Place the system file to update this keyboard here.

PATCH

The patch file is saved here.

NOTE: If your USB drive is formatted so the SK cannot read it, the SK will initialize your drive automatically.

tips EXTENSION OF THE SETUP FILE

The extension "SET" is automatically given to the setup file treated on this keyboard.

tips EXTENSION OF THE PATCH FILE

The extension "PAT" is automatically given to the patch file treated on this keyboard.

INITIALIZE THE USB FLASH DRIVE

A “fresh” The USB flash drive must be “initialized”. The initializing procedure is as follows:

- ❖ When initializing is completed, all the contents of the USB flash drive are erased.

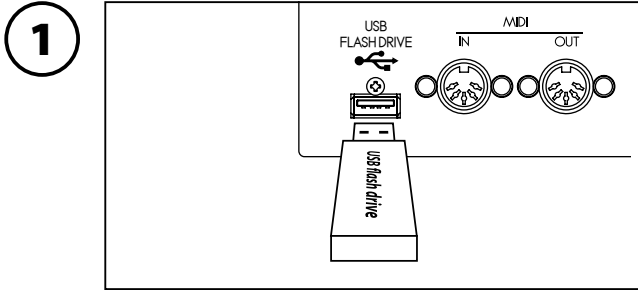

Insert the USB flash drive to the USB MEMORY jack.
Wait until the display “Confirming USB. Please wait...” disappears.

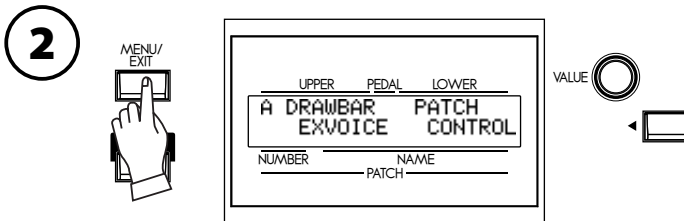

Press the [MENU/EXIT] button to display the Menu.

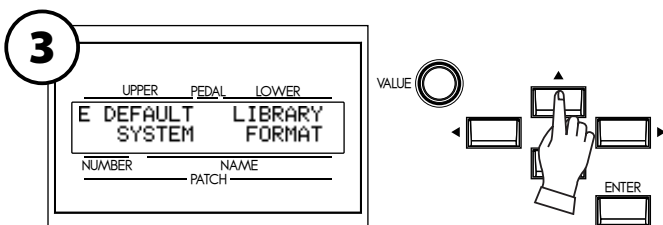

Select Page E with the [▲],[▼] buttons.

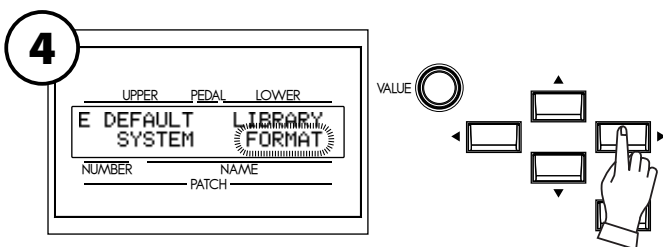

Select the “FORMAT” with the [▶] button.

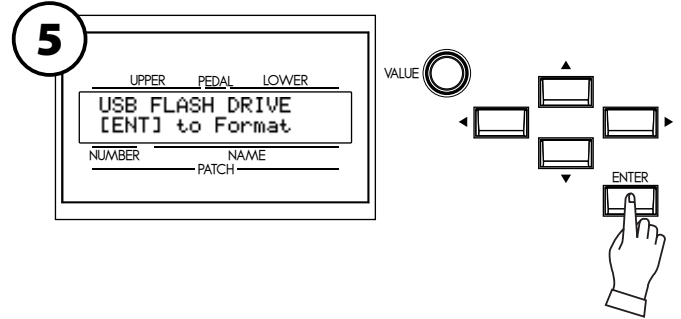

Press the [ENTER] button.
The FORMAT (=initializing) mode is displayed.

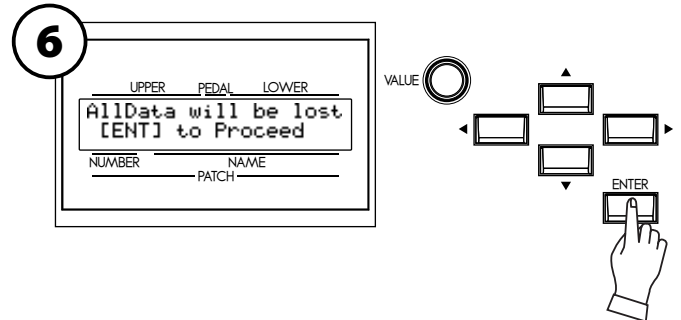

Press the [ENTER] button.
Confirmation message is displayed.

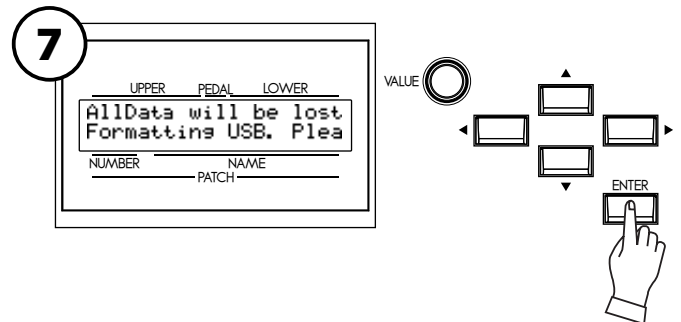

Press the [ENTER] button.
Initialization starts. It takes about 3 seconds.

NOTE: If you choose to not initialize, just press the [MENU/EXIT] button.

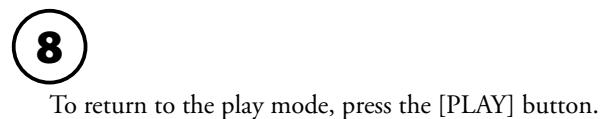

To return to the play mode, press the [PLAY] button.

SETUP PROCEDURES

Save or Load the SET-UPS to/from the USB flash drive in the SETUP mode.

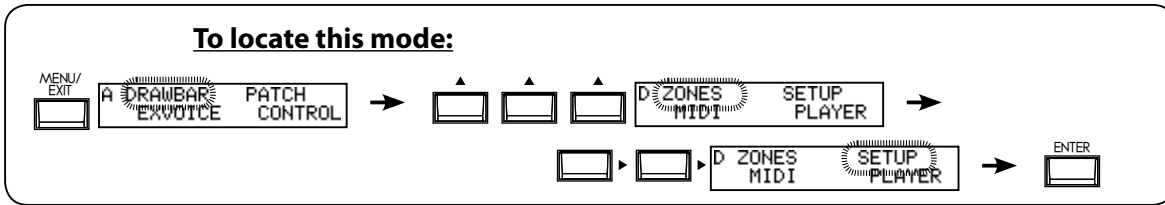

HOW TO READ THE DISPLAY

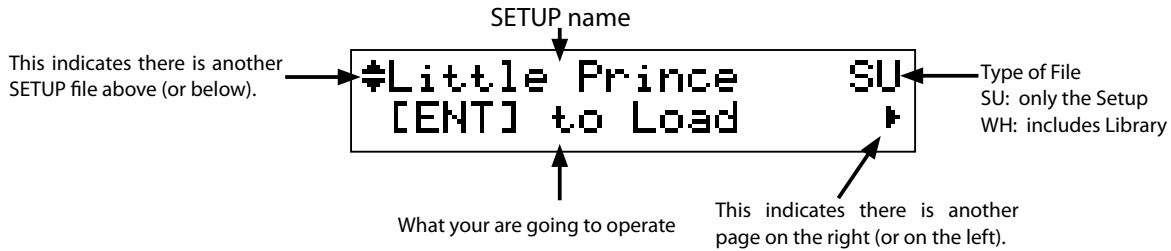

SAVE THE SETUP

1 Check that the USB flash drive is correctly inserted.

2 Locate the SETUP mode.

WHAT DOES THIS MEAN?

- USB is not ready.
- USB flash drive is not correctly inserted.

3 Select the "New File" by pressing the [▲] button (or turning the [VALUE] knob) a few times.

4 If you want to save the sound library, too, press the [▶] button to display the "TYPE" and change the value from "SETUP" to "WHOLE" with the [VALUE] knob. Then press the [◀] button and return to the file display mode.

5 If you press the [ENTER] button, it is saved. With the WHOLE file, it can take up to 3 hours maximum for saving.

6 A temporary name "SETUPxx" is automatically given to the saved setup file.

CHANGE THE SETUP NAME

1



Select the setup file you want to change the name of with the [▲],[▼] buttons or the [VALUE] knob.

2

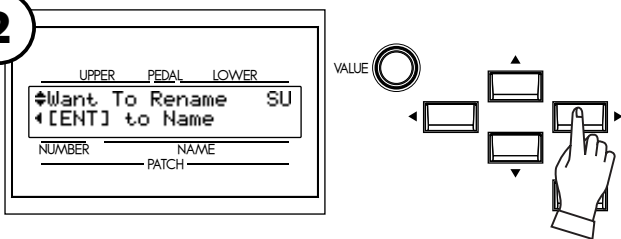

Press the [▶] button. "[ENT] to Name" is displayed.

3

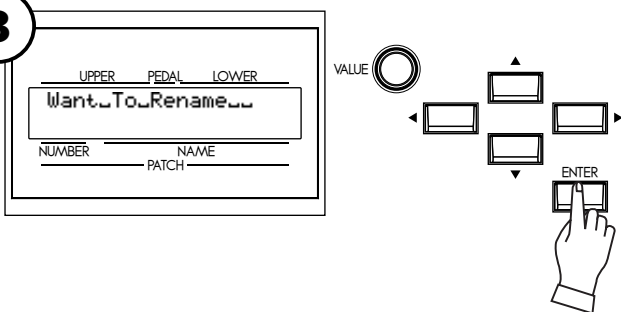

Press the [ENTER] button. This is the screen where the name is entered.

4

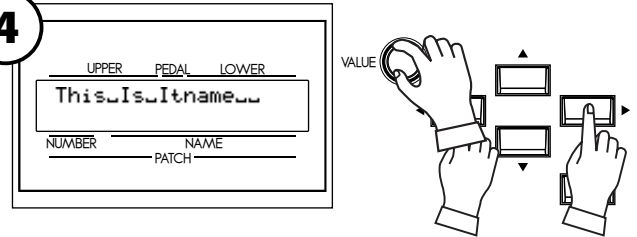

Enter the new setup name.

[◀,▶] buttons

Move the cursor. The length is up to 16 letters.

[VALUE] knob

Select letters.

Valid characters are: digits, symbols, large and small alphabets.

5

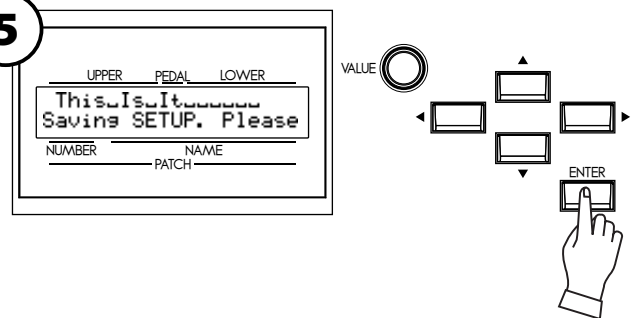

Press the [ENTER] button. The setup name is changed.

tips WHAT CONTENTS ARE SAVED?

Setup: Global parameter, Patch parameter, Leslie Cabinet, Custom Tone Wheel, Temporary (except the Expression Source and Device ID)

Whole: In addition to the Setups, the whole sound library in the organ.

LOAD THE SETUP

❖ If you do this operation, the settings in this keyboard are replaced with the newly loaded setups. You should save important data beforehand (p. 120).

1

Check the USB flash drive is correctly inserted.

2



Locate the SETUP mode.

3

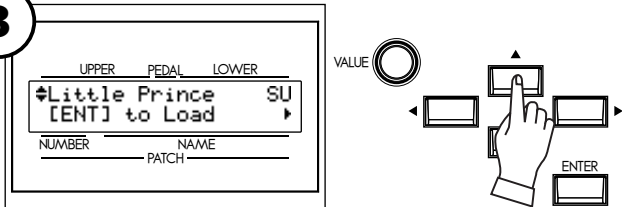

Select the Setup file to load with the [▲],[▼] buttons or the [VALUE] knob.

4

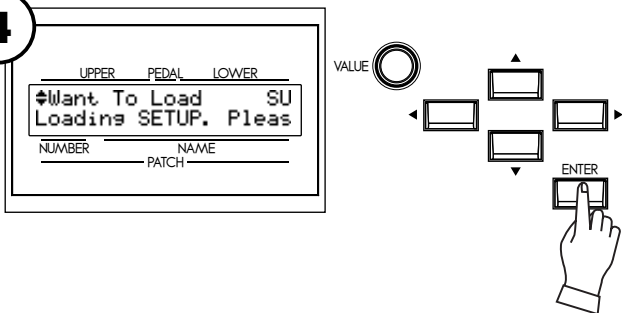

Press the [ENTER] button. The Setup is loaded.
In case of the WHOLE file, loading can take up to a maximum 3 hours.

DELETE THE SETUP

1

Check the USB flash drive is correctly inserted.

2



Locate the SETUP mode.

3

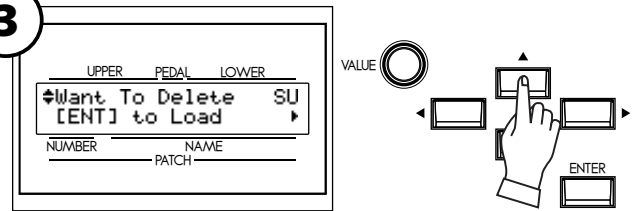

Select the setup file to delete with the [▲],[▼] buttons or the [VALUE] knob.

4

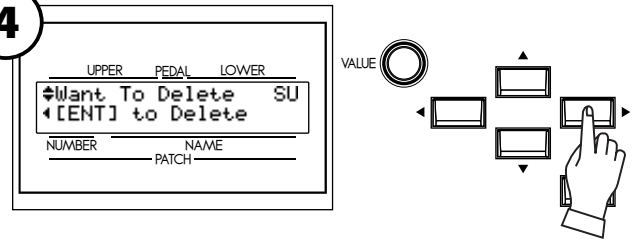

Press [▶] button twice. "[ENT] to Delete" is displayed.

5

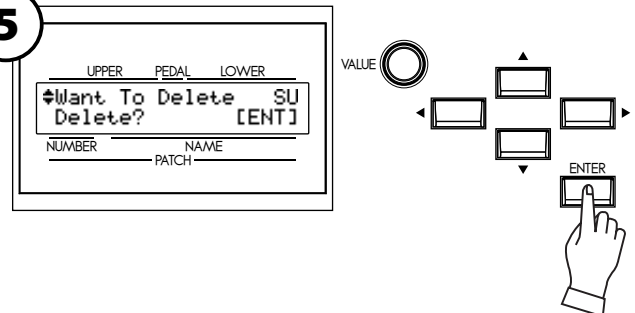

Press the [ENTER] button. "Delete?" is displayed. Now press the [ENTER] button again. The setup is deleted.

NOTE: If you do not wish to delete the setup, touch the [MENU/EXIT] button.

Save or Load the PATCHes to/from the USB flash drive in the PATCH mode, not SETUP mode on last page.

To locate this mode:

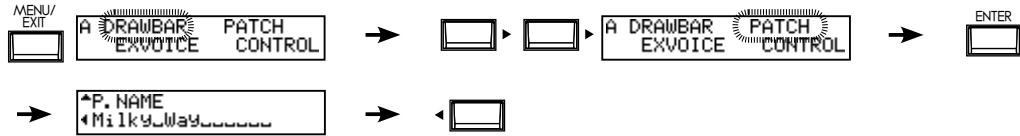

HOW TO READ THE DISPLAY

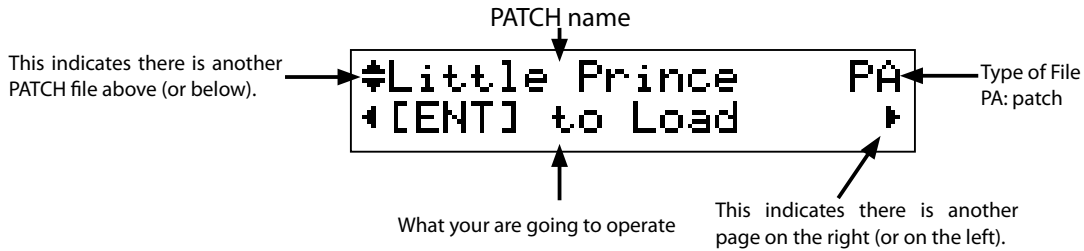

SAVE THE PATCH FILE

1 Check that the USB flash drive is correctly inserted.

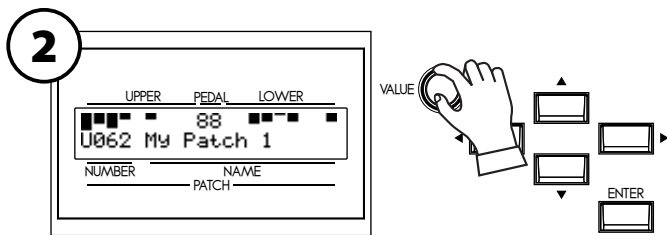

Choose the Patch which you wish to save.

3

To locate the PATCH mode, please refer to the illustration above, "To locate this mode".

WHAT DOES THIS MEAN?

- USB is not ready.
- USB flash drive is not correctly inserted.

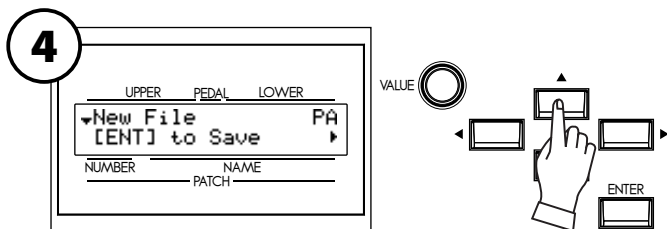

Select the "New File" by pressing the [▲] button (or turning the [VALUE] knob) a few times.

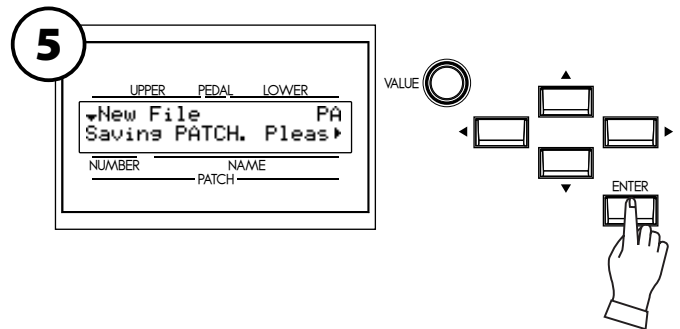

If you press the [ENTER] button, it is saved.

WHAT DOES THIS MEAN?

- Same name exists.
- There is a file with same name already. Change the patch name on the SK, or delete the file with same name in the USB flash drive (next page).



A file name same as Patch name is automatically given to the saved patch file.

LOAD THE PATCH FILE

❖ If you do this operation, a patch in this keyboard are replaced with the newly loaded patch. You should save important data beforehand (p.123).

1

Check the USB flash drive is correctly inserted.

2



Locate the PATCH mode with refer to upper figure on last page.

3

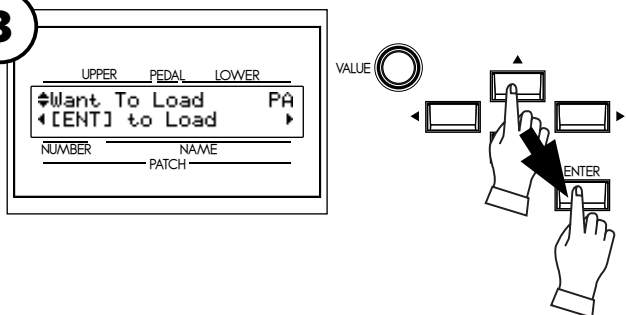

Select the Patch file to load with the [▲],[▼] buttons or the [VALUE] knob, and press [ENTER].

4

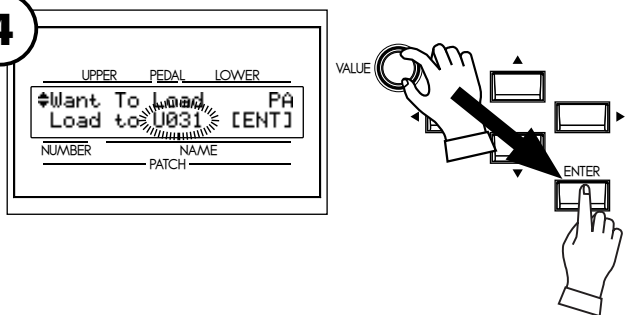

Select the Patch number to be replaced.
Press the [ENTER] button. The Patch is loaded.

DELETE THE PATCH FILE

1

Check the USB flash drive is correctly inserted.

2

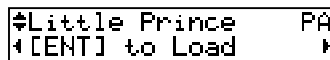

To locate the PATCH mode, please refer to the illustration or top of page 123.

3

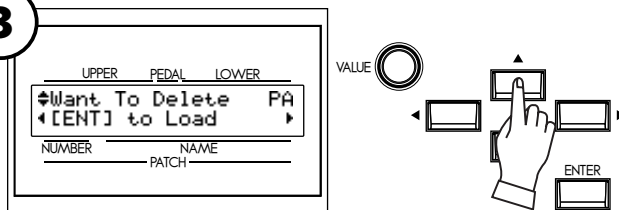

Select the Patch file to delete with the [▲],[▼] buttons or the [VALUE] knob.

4

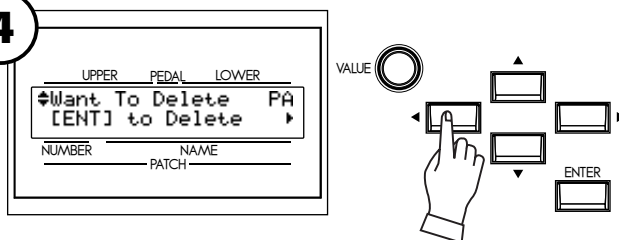

Press [◀] button once. "[ENT] to Delete" is displayed.

5

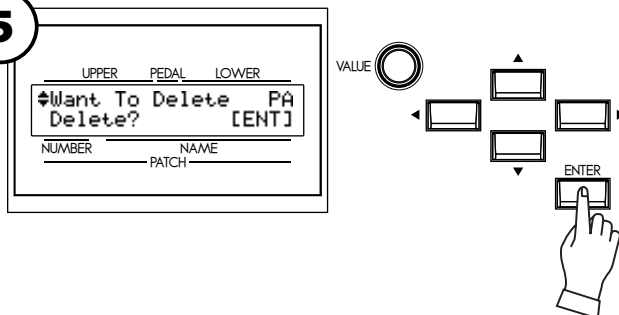

Press the [ENTER] button. "Delete?" is displayed. Now press the [ENTER] button again. The Patch is deleted.

NOTE: If you do not wish to delete the setup, touch the [MENU/EXIT] button.



**MUSIC
PLAYER**

BEFORE PLAYING BACK

You can play audio files saved in the USB flash drive. Enjoy playing a rhythm section recorded in advance as an accompaniment for your one-man band or practising the keyboard performance playing/listening to your Favorites.

FILE TYPE AND PLACING FOLDER

FILE TYPE

The audio file types possible to reproduce on this keyboard are as follows:

- ◆ WAV type (44.1 kHz 16 bit stereo)
- ◆ MP3 type (44.1 kHz 64 to 192 kbps stereo)
 - ❖ *The mp3 file may cause intermittent sound during playback with hardly keyboard play. We recommend that use wav file for serious program.*

tips HANDLING THE USB FLASH DRIVE

See the previous paragraph "Save your setup" for the handling details of the USB flash drive (P. 118).

PLACING FOLDER

When the USB flash drive onto this keyboard, the folder for the music player is automatically prepared.

\HAMMOND\SK\AUDIO\

Using your Computer, place the files you wish to play in this folder. This keyboard identifies up to 99 files.

NAMES OF MUSIC TO BE DISPLAYED

If the audio file is in the WAV type, the file name is displayed as the name of the song.

If the audio file is in the MP3 type, the title of the ID3 tag (V1 or V2) is displayed as the name of the music.

PLAYING ORDER

For playing the audio file in the show etc. in the order as prepared beforehand, put the file name in the ascending order.

Example:

```
00_Audio_Check.wav
01_Show_Opener.wav
02_Self_Introduction.wav
03_Hit_Number.wav
04_Ballad.wav
05_Anchor.wav
```

HOW TO READ THE DISPLAY

The illustration is of the Song List mode.

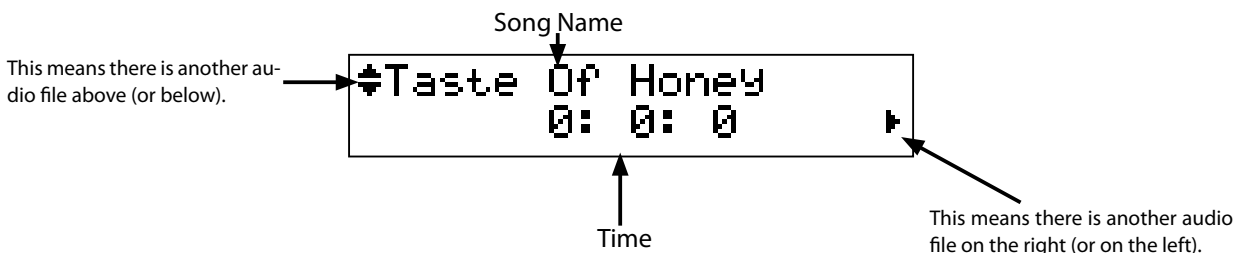

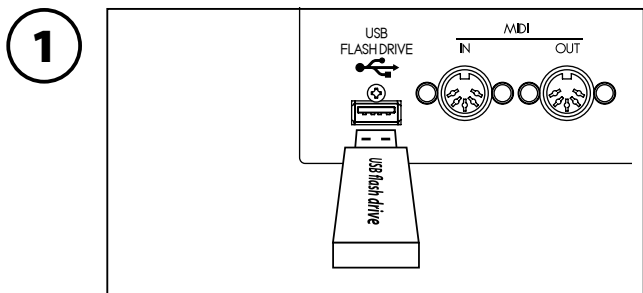

Insert the USB flash drive to the USB FLASH DRIVE jack. Wait until the display “Confirming USB. Please wait.” disappears.

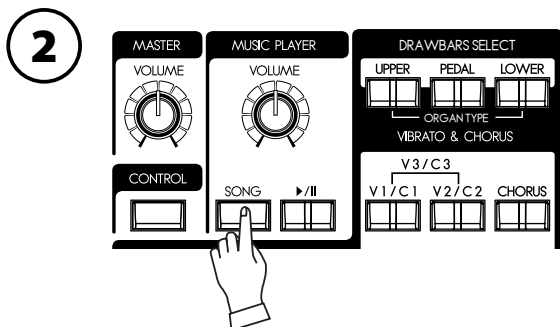

Press the [SONG] button to display the song list. You can locate the song list mode pressing the [MENU/EXIT] - Page D - PLAYER - [ENTER].

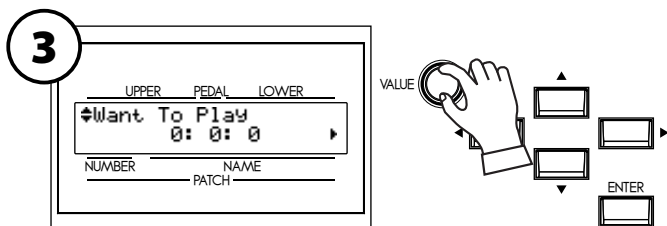

Select the audio file you want to play with the [VALUE] knob or the [▲],[▼] buttons.

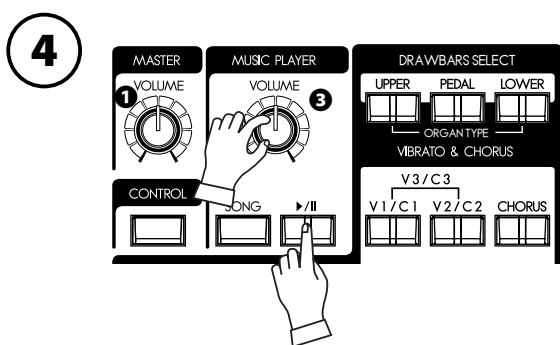

TO PLAYBACK

Press the [▶/||] button (LED On). The play starts.

TEMPORARY PAUSE

Press the [▶/||] button again (LED Blink). The play temporarily stops.

TO RETURN TO THE TOP OF THE SONG

Press the [SONG] button in the song list mode ([▶/||] LED Off).

TO ADJUST THE PLAY VOLUME

Adjust volume with the [VOLUME] knob (3). It adjusts independently of the [MASTER VOLUME] knob (1).

MUSIC PLAYER MODES

1

Confirm the USB flash drive is inserted correctly.

2



Locate the song list mode.

3

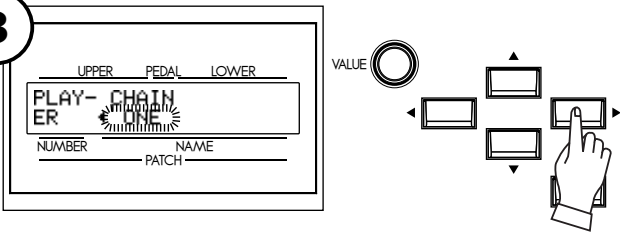

Move the cursor to the item CHAIN with the [▶] button.

4

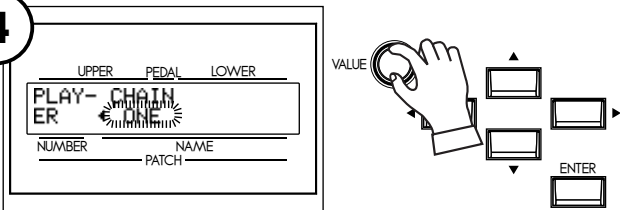

Select how to play with the [VALUE] knob.

- ALL:** Repeats all songs. When the currently playing song ends, the next song automatically starts playing.
- ONE:** When the currently playing song ends, it stops the playback.
- SHUF:** When the currently playing song ends, the next song is randomly selected and played.



WHAT IS VOICE LIBRARY?

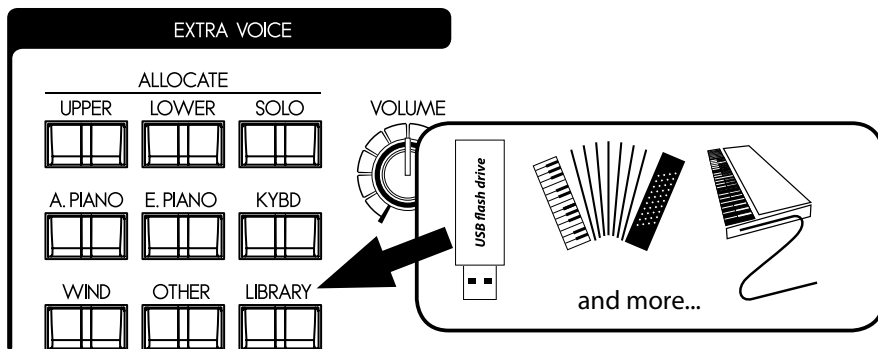

You can additionally register new voices into the [LIBRARY] button of the Extra Voice section using the USB flash drive. This is called “Voice Library”.

The voice library will be announced periodically on our web sites. Several sounds are registered as a default settings (P. 136).

tips HANDLING THE USB FLASH DRIVE

See the previous paragraph “Save your setup” for the handling details of the USB flash drive (P. 118).

FILE TYPE AND THE PLACING FOLDER

FILE TYPE

The voice library is offered in the following types: If the file is compressed in some way, first expand it beforehand.

“Libxxxxx.SYS” (xxxx is name of voice library)

PLACING FOLDER

When you insert the USB flash drive to this keyboard, the folder of the voice library is automatically created.

\HAMMOND\SK\LIB

Save the library file you want to register here using the personal computer.

This keyboard can identify up to 99 files.

VOICE LIBRARY AND SETUPS

You can record settings created with the sound library to the patches. If the contents of the sound library change, the sound of the patch becomes different from that of the recorded one.

The memory dump or the USB flash drive is used for saving and loading the setups. However, if you want to save/load including the sound library, be sure to record as WHOLE to the USB flash drive. (P. 120 - 4) The contents of the sound library are not recorded in any other way.

LOADING THE VOICE LIBRARY

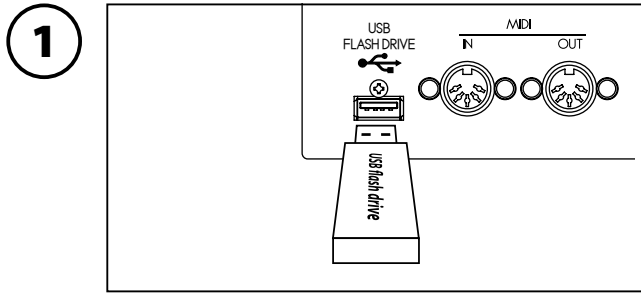

Insert the USB flash drive to the USB FLASH DRIVE jack. Wait until the display “Confirming USB. Please wait...” disappears.

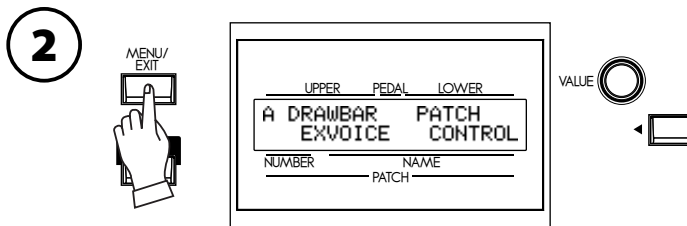

Display the menu with the [MENU/EXIT] button.

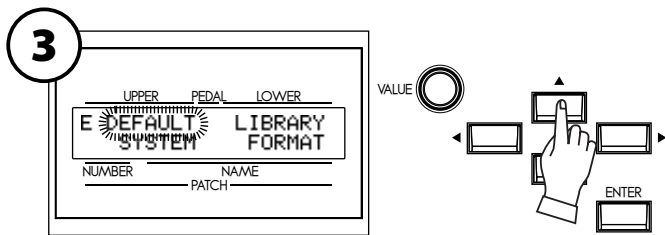

Select the Page E with the [▲],[▼] button.

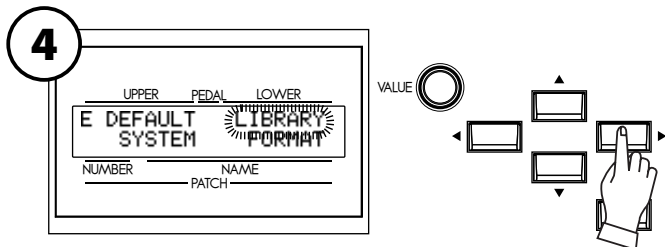

Select LIBRARY with the [▶] button.

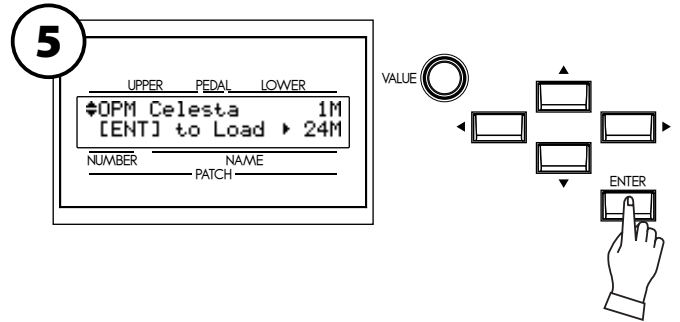

Press the [ENTER] button. Now you have come to the library function mode.

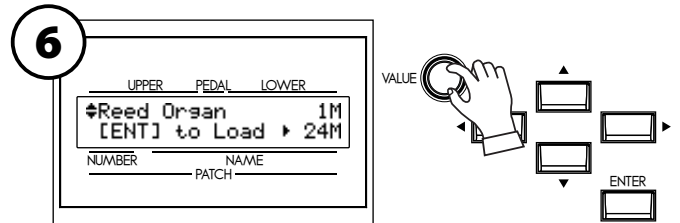

Select the voice library you want to additionally register with the [VALUE] knob or the [◀],[▶] buttons.

NOTE: The capacity of the sound library file on the upper right of the display, and the remaining capacity of this unit on the bottom right. You can not additionally register larger files than the remaining capacity.

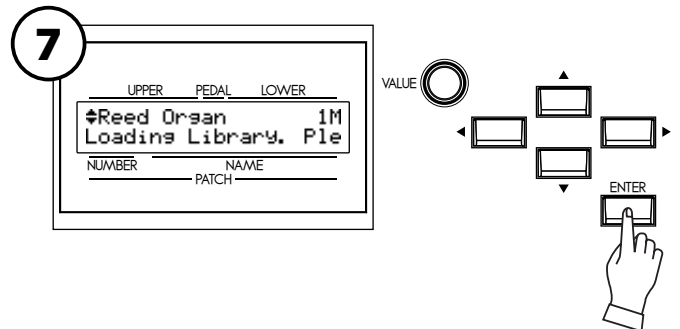

Press the [ENTER] button. Loading the voice library starts. It may take a while for this procedure to complete.

Required time for registration depends on the capacity. It takes a maximum of 3 hours.

DELETE A LIBRARY

When the remaining capacity of this unit is not enough for the sound library you want to load, you can increase the capacity by deleting an unnecessary portion of the library.

1

```

┌───┐
│Reed Organ      1M
│[ENT] to Load ▶ 24M
└───┘
    
```

Locate the voice library function mode.

2

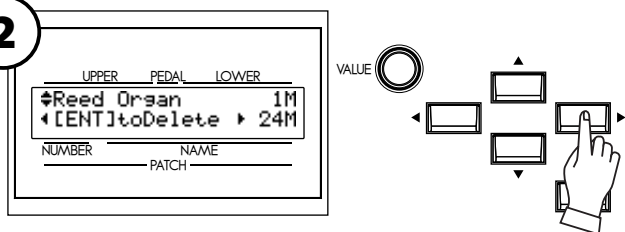

Press the [▶] button. The selected library is displayed.

3

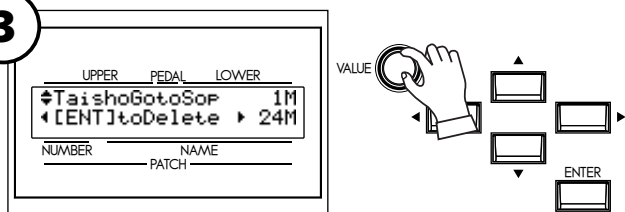

The library's size is displayed on the upper right. Select the library you want to delete with the [VALUE] knob or the [▲],[▼] buttons, referring to the display.

4

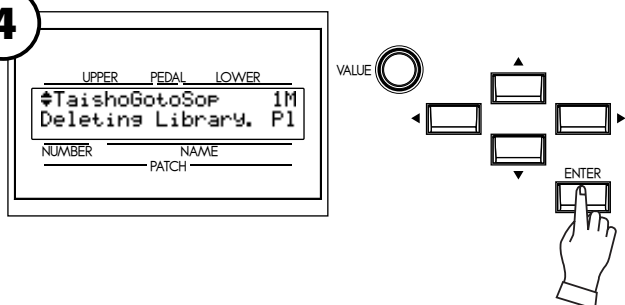

Press the [ENTER] button. The deleting treatment is done and the new remaining capacity is displayed on the bottom right.

CLEAR ALL LIBRARIES

You can delete all the existing voice library when you want to freshly make the set up.

1

```

┌───┐
│Reed Organ      1M
│[ENT] to Load ▶ 24M
└───┘
    
```

Locate the voice library function mode.

2

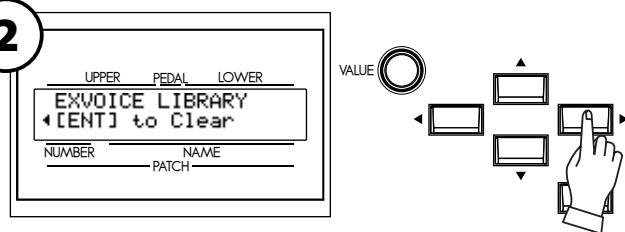

Press the [▶] button twice. 'Clear' page appears.

3

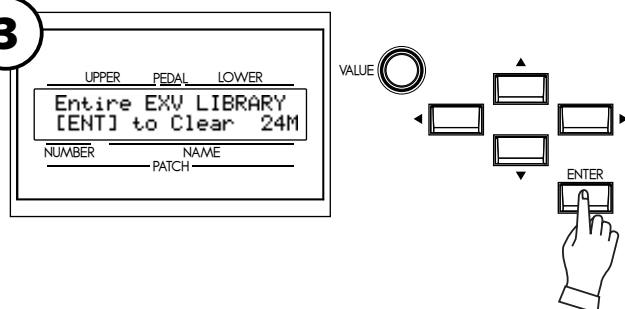

Press the [ENTER] button. The confirmation message whether you really want to delete it or not is displayed.

4

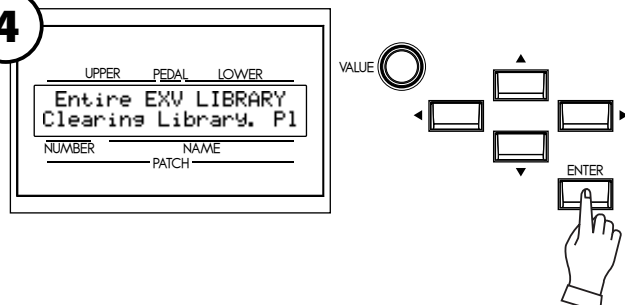

Press the [ENTER] button again. All the voice library registered to this keyboard is deleted.

If you do not wish to delete, touch the [MENU/EXIT] button.



Troubleshooting

- ◆ **Malfunction of the buttons, the keys, etc.**
 - ◆ Turn off the POWER switch once, then turn it on again. If this procedure is not successful, turn off the POWER switch. While pressing the [RECORD] button, turn the POWER switch on again. (Note that in this case, all parameters return to their factory-preset status.)
- ◆ **No sound is produced when the keys are pressed.**
 - ◆ The MASTER VOLUME is at the minimum setting. ⇒
Adjust the volume with the MASTER VOLUME control.
 - ◆ The local control is turned OFF. ⇒
Turn the local control ON, if not using an external sequencer or computer. (P. 114 #3)
 - ◆ Leslie speaker is connected. ⇒
Line out and Phones jack does not output the sound of rotary channel when the Leslie speaker is connected.
- ◆ **Cannot hear the some notes.**
 - ◆ Hooked-up with mono. ⇒
Set the audio mode at "MONO". (P. 104 #1)
- ◆ **The Manual Bass does not sound when the Split is turned off.**
 - ◆ The Manual Bass - Mode is set at "CHRD" (detecting chord on the LOWER part). ⇒
Set the mode at "LOW" or "POLY". (P. 112 #1)
- ◆ **The expression does not change.**
 - ◆ The Expression Source assignment is not correctly set. ⇒
Correctly set the Expression Source item in the CONTROL mode. (P. 128)
 - ◆ The Expression mode of Overdrive is set at "OD Only" or "Input". ⇒
Set the Expression mode at except "OD Only" or "Input". (P. 92)
 - ◆ The Source of Multi-Effect is set at "EXP". ⇒
Set the Source at except "EXP". (P. 92)
- ◆ **The Foot switch does not work properly.**
 - ◆ The Foot Switch assignment is not correctly set. ⇒
Correctly set the Foot Switch in the CONTROL mode. (P. 78)
- ◆ **No functions the Split or Manual Bass.**
 - ◆ MIDI IN mode is set at "LOWER", "LOW+PED", "UPPER" or "UPP+PED". ⇒
Set the MIDI IN mode depending on the purpose. (P. 114 #2)
- ◆ **The Manual Bass Does not sound.**
 - ◆ The Foot Switch assignment is set at "MANUAL BASS". ⇒
Press the Foot Switch or set the Foot Switch assignment at except "MANUAL BASS". (P. 78)
- ◆ **When the patch is called, the sound is interrupted.**

If the following values are different between the patches, there will be a brief interruption:

 - ◆ Organ type
 - ◆ Extra Voice
 - ◆ Multi-Effects
 - ◆ Octave
 - ◆ Split
 - ◆ Manual Bass
 - ◆ Key Range
- ◆ **The MENU/EXIT or RECORD does not work.**
 - ◆ The Display Lock is enabled. ⇒
Disable the Display Lock (P. 36).

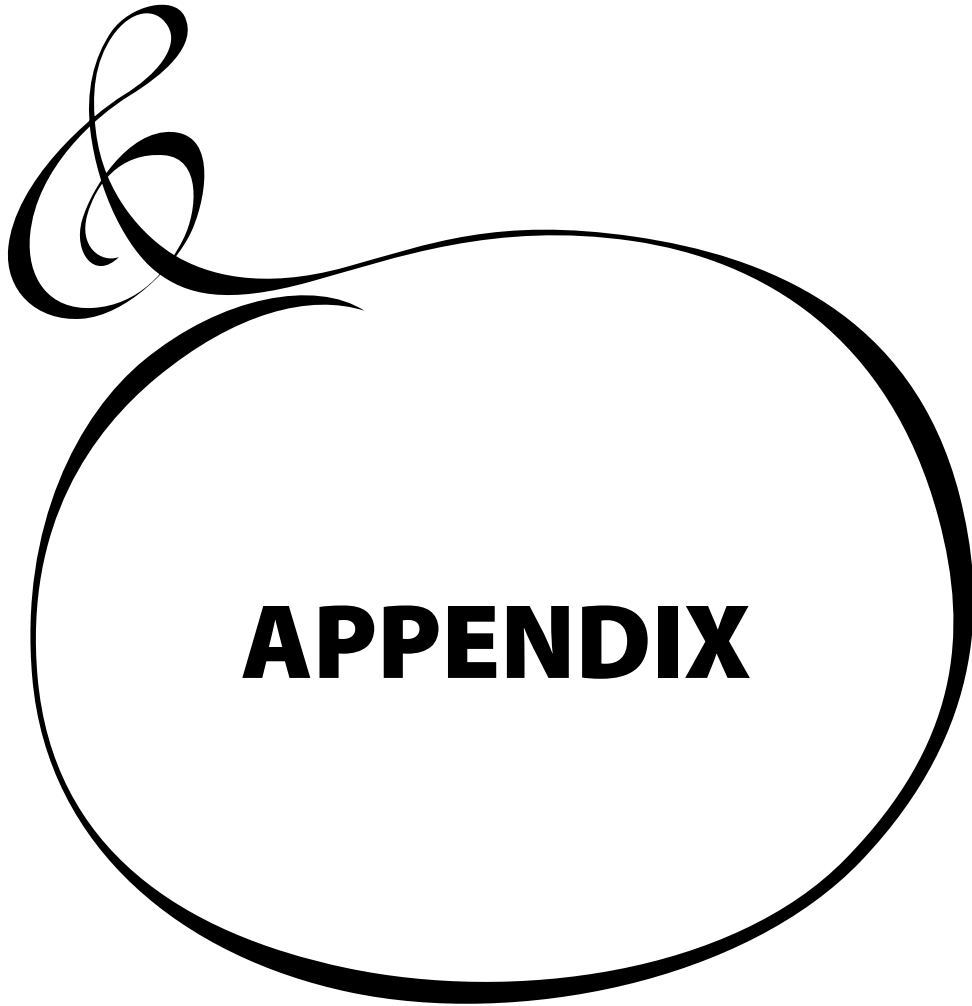

APPENDIX

EXTRA VOICE INSTRUMENT LIST

Group	Number	Description
0 A. Piano	0	Stereo Grand Pf. Concert grand piano. The maximum sound effect is obtained when connected stereo.
0 A. Piano	1	Bright Stereo Grand Pf.
0 A. Piano	2	Mono Grand Pf. The mono version of above. Use this if connection is monaural. The clumsy "omission" due to the interfering right and left channels is avoided.
0 A. Piano	3	Bright Mono Grand Pf.
0 A. Piano	4	Electric Grand Pf. Electric grand piano which picks up the string vibration by hammer action. The following "EQ" means equalized edition.
0 A. Piano	5	Electric Grand Pf. EQ
0 A. Piano	6	Stereo Grand Pf. Pad The mellow "Pad" sound added on Stereo Grand Pf.
0 A. Piano	7	Electric Grand Pf. Pad The mellow "Pad" sound added on Electric Grand Pf.
0 A. Piano	8	3rd Harmonic GP Grand Piano with 3rd harmonic note.
0 A. Piano	9	Stereo GP Oldtime Pcd Stereo Grand Pf with Prochord. It sounds harmonized melody by playing chord on LOWER keyboard, single noted melody on UPPER keyboard.
0 A. Piano	10	Stereo GP Pad 2 Variation of "Stereo Grand Pf. Pad".
0 A. Piano	11	Electric GP Pad 2 Variation of "Electric Grand Pf. Pad".
1 A. Piano 2	0	Upright Pf. Upright piano. The maximum sound effect is obtained when connected stereo. To use in monoural connection, select the Mono Upright Pf.
1 A. Piano 2	1	Mono Upright Pf.
1 A. Piano 2	2	Honky Tonk Pf. Honky-tonk piano which de-tuned the strings of the upright piano. To use in monoural connection, select the Mono Honky Tonk Pf.
1 A. Piano 2	3	Mono Honky Tonk Pf.
2 E. Piano	0	E. Piano Rd1 Tone-bar electric piano (first edition). The following "Pan", "Phase", "OD" are using each effect.
2 E. Piano	1	EP Rd1 Pan
2 E. Piano	2	EP Rd1 Phase
2 E. Piano	3	EP Rd1 OD
2 E. Piano	4 - 7	E. Piano Rd2, Pan, Phase, OD Tone-bar electric piano (second edition). The following "Pan", "Phase", "OD" are using each effect.
2 E. Piano	8	E. Piano FM FM synth electric piano. The following "Chorus" is using chorus effect.
2 E. Piano	9	EP FM Chorus
2 E. Piano	10	E. Piano Wur Reed-driven electric piano. The following "OD" is using overdrive effect.
2 E. Piano	11	EP Wur OD
2 E. Piano	12	EPiano Bass "E. Piano Rd2" for bass line.
2 E. Piano	13	EPiano Wur Mellow Mellow setting of "E. Piano Wur".
3 Keyboard	0	Harpsi 8' Harpsichord. "8'" is normal, "8' 4'" is in octave unison, "Lute" means treble damped.
3 Keyboard	1	Harpsi 8' 4'
3 Keyboard	2	Harpsi 8' Lute
3 Keyboard	3	Clav. AC Electric clavichord. The following "AC", "AD", "BC", "BD" means each pick-up selector.
3 Keyboard	4	Clav. AD
3 Keyboard	5	Clav. BC
3 Keyboard	6	Clav. BD
3 Keyboard	7 - 10	Clav. AC, AD, BC, BD Wah The sound "Clav. AC" - "Clav. BD" with "Touch-Wah" effect. Playing harder, the filter opens wider.
3 Keyboard	11 - 14	Clav. AC, AD, BC, BD Cry The sound "Clav. AC" - "Clav. BD" with "Pedal Wah" effect. If the expression pedal is connected, you can get the wah effect with pedal operation.
3 Keyboard	15	Clavition On the left hand side still sounds if the key is released, on the right hand side sounds a chord with a note is pressed like "Superst...".
3 Keyboard	16	Lucy Simulates an electronic organ, that heard intro. of "Lucy In The...". The following "Tremolo" is added its effect. The effective method is playing arpeggio with slowly and staccato.
3 Keyboard	17	Lucy Tremolo
3 Keyboard	18	Clavn. Simulates the electronic violin clavier in 1950's.
3 Keyboard	19	Don't Run The reed sound like "Walk, Don't...".
3 Keyboard	20	Telstar Simulates the lead sound what used in "Telstar".
3 Keyboard	21	Blue Star Simulates an electronic organ, like "Blue Star".
3 Keyboard	22	Accordion A120 1/0/0 Variations of Suzuki accordion A-120.
3 Keyboard	23	Accordion A120 1/1/0
3 Keyboard	24	Accordion A120 1/0/1
3 Keyboard	25	Accordion A120 1/1/1
3 Keyboard	26	Accordion A120 1/2/0
3 Keyboard	27	Accordion A120 1/2/1
3 Keyboard	28	Accordion A120 0/1/0
3 Keyboard	29	Accordion A120 0/2/0
3 Keyboard	30	Accordion A120 0/1/1
3 Keyboard	31	Accordion A120 0/2/1
3 Keyboard	32	Accordion A120 0/0/1
3 Keyboard	33	Accordion A120 OD Overdriven accordion.
3 Keyboard	34	Acnd Mellow 0/1/0 Mellow accordion. On "MMM", you can adjust the beating by the Chorus - Depth of the Extra Voice effects.
3 Keyboard	35	Acnd Mellow 0/2/0
3 Keyboard	36	Acnd Mellow MMM
3 Keyboard	37	Acnd Bright 0/1/0 Bright accordion. On "MMM", you can adjust the beating by the Chorus - Depth of the Extra Voice effects.
3 Keyboard	38	Acnd Bright 0/2/0
3 Keyboard	39	Acnd Bright MMM
3 Keyboard	40	Doob Real Love Added overdrive and phaser effects on "Clav. AD".
4 Wind	0	Trumpet Straight The instruments following "Wind" group sounds simply. They does not work Prochord function.
4 Wind	1	Trumpet Vibrato
4 Wind	2	Trumpet Muted

Group		Number	Description
4	Wind	3	Trombone Straight
4	Wind	4	Trombone Muted
4	Wind	5	Flute Vibrato
4	Wind	6	Al. Sax Straight
4	Wind	7	Al. Sax Vibrato
4	Wind	8	Tn. Sax Straight
4	Wind	9	Tn. Sax Vibrato
4	Wind	10	Ba. Sax Straight
4	Wind	11	Tp + Tb Straight
4	Wind	12	Tp + Tb Vibrato
4	Wind	13	Tp + Tb Muted
4	Wind	14	Flute Pcd
4	Wind	15	BigBand Sax Pcd
4	Wind	16	BigBand Pcd
4	Wind	17	BigBand FD Pcd
4	Wind	18	Quartet 1 Pcd
4	Wind	19	Quartet 2 Pcd
4	Wind	20	Jazz Brass Pcd
4	Wind	21	Jazz Brass FD Pcd
4	Wind	22	Mute Combo 1 Pcd
4	Wind	23	Mute Combo 2 Pcd
4	Wind	24	BigBand Gliss Up Pcd
4	Wind	25	Two Trumpets
4	Wind	26	Unison Brass
4	Wind	27	Synth Brass Afri
4	Wind	28	Synth Brass Rosa
5	Other	0	Glockenspiel
5	Other	1	Vibraphone
5	Other	2	Solly Strings
5	Other	3	Solly Strings o
5	Other	4	Solly Strings Long
5	Other	5	Solly Strings o Long
5	Other	6	Syn. Strings 1
5	Other	7	Syn. Strings 1 o
5	Other	8	Syn. Strings 2
5	Other	9	Syn. Strings 2 o
5	Other	10	Syn. Strings 3
5	Other	11	Sweep Pad
5	Other	12	Slice Pad
5	Other	13	H. Bell Pad
5	Other	14	Glock. Pad
5	Other	15	Square Lead
5	Other	16	Square Mellow
5	Other	17	Saw Lead
5	Other	18	Saw Duo Pcd
5	Other	19	P. O. Love
5	Other	20	Funny Lead
5	Other	21	Funny Duo Pcd
5	Other	22	Syn. Harp
5	Other	23	Noise Zap
5	Other	24	Jet
6	Library	0	VxJ Bright
6	Library	1	VxJ Brass
6	Library	2	VxJ Mellow
6	Library	3	VxJ Flute
6	Library	4 - 7	VxJV Bright, Brass, Mellow, Flute
6	Library	8 - 11	VxJS Bright, Brass, Mellow, Flute

Example Select Group 2, Number 3 via NRPN.....Bx 03 06 62 50 06 02 26 00 63 07 62 50 06 03 26 00 (x = Control channel)

MIDI TEMPLATES

MIDI TEMPLATES OF SK1, -73, -88

Template		Basic	Two Manual	Pedal KBD
Messages	MIDI IN	Sequence	Lower Upper (SK1-73, -88)	Pedal
	Local Control	On	On	On
	NRPN	On	On	On
	Program Change	On	On	On
	Drawbar Registration	On	On	On
Transmit Channel	Tx. Upper	1	1	1
	Tx. Lower	2	2	2
	Tx. Pedal	3	3	3
	Rx. Upper	1	1 (disregarded, off)	1 (disregarded, off)
	Rx. Lower	2	2 (disregarded, omni)	2 (disregarded, off)
	Rx. Pedal	3	3 (disregarded, off)	3 (disregarded, omni)
	External Zone	Off	Off	Off
Comments	Use this template to record/play the performance only on this unit with the external sequencer.		Use this template to play the LOWER keyboard (UPPER keyboard on SK1-73, -88) connecting to the MIDI IN jack.	Use this template to play the PEDAL keyboard connecting to the MIDI IN jack.

Template		3KBD	Use Ex. Zone	Use Ex. w/2Man
Messages	MIDI IN	Low + Ped Upp + Ped (SK1-73, -88)	Sequence	Lower Upper (SK1-73, -88)
	Local Control	On	On	On
	NRPN	On	On	On
	Program Change	On	On	On
	Drawbar Registration	On	On	On
Transmit Channel	Tx. Upper	1	Off	Off
	Tx. Lower	2	Off	Off
	Tx. Pedal	3	Off	Off
	Rx. Upper	1	1	1 (disregarded, off)
	Rx. Lower	2	2	2 (disregarded, omni)
	Rx. Pedal	3	3	3 (disregarded, off)
	External Zone	Off	On	On
Comments	Use this template to play the LOWER and PEDAL keyboards (UPPER and PEDAL keyboards on SK1-73, -88) merging and connecting to the MIDI IN jack.	Use this template to play only this keyboard and control the MIDI equipment connected to the MIDI OUT jack with the External Zones.	Use this template to play this keyboard and the LOWER keyboard (UPPER keyboard on SK1-73, -88) connected to the MIDI IN jack and control the MIDI equipment connected to the MIDI OUT jack with the External Zone.	

Template		Use Ex. w/PK	Use Ex. w/3KBD	Extra Voice
Messages	MIDI IN	Pedal	Low + Ped Upp + Ped (SK1-73, -88)	ExVoice
	Local Control	On	On	On
	NRPN	On	On	On
	Program Change	On	On	On
	Drawbar Registration	On	On	On
Transmit Channel	Tx. Upper	Off	Off	1
	Tx. Lower	Off	Off	2
	Tx. Pedal	Off	Off	3
	Rx. Upper	1 (disregarded, off)	1	1 (disregarded, off)
	Rx. Lower	2 (disregarded, off)	2	2 (disregarded, off)
	Rx. Pedal	3 (disregarded, omni)	3	3 (disregarded, off)
	External Zone	On	On	Off
Comments	Use this template to play this keyboard and the Pedal keyboard connected to the MIDI IN jack and control the MIDI equipment connected to the MIDI OUT jack with the External Zone.	Use this template to play the merged LOWER and PEDAL keyboards (UPPER and PEDAL keyboards on SK1-73, -88) connecting to the MIDI IN jack and control the MIDI equipment connected to the MIDI OUT jack with the External Zone.	Use this template to play only the Extra Voices on the MIDI keyboard connected to the MIDI IN jack.	

MIDI TEMPLATES OF SK2

Template		Basic	Pedal KBD	Use Ex. Zone
Messages	MIDI IN	Sequence	Pedal	Sequence
	Local Control	On	On	On
	NRPN	On	On	On
	Program Change	On	On	On
	Drawbar Registration	On	On	On
Transmit Channel	Tx. Upper	1	1	Off
	Tx. Lower	2	2	Off
	Tx. Pedal	3	3	Off
	Rx. Upper	1	1 (disregarded, off)	Off
	Rx. Lower	2	2 (disregarded, off)	Off
	Rx. Pedal	3	3 (disregarded, omni)	Off
	External Zone	Off	Off	On
Comments		Use this template to record/playback the performance of only this keyboard to the external sequencer.	Use this template to play on the Pedal keyboard connecting to the MIDI IN jack.	Use this template to play only on this keyboard and control the MIDI equipment connected to the MIDI OUT jack with the External Zone.

Template		Use Ex. w/PK	Extra Voice
Messages	MIDI IN	Pedal	ExVoice
	Local Control	On	On
	NRPN	On	On
	Program Change	On	On
	Drawbar Registration	On	On
Transmit Channel	Tx. Upper	Off	1
	Tx. Lower	Off	2
	Tx. Pedal	Off	3
	Rx. Upper	1 (disregarded, off)	1 (disregarded, off)
	Rx. Lower	2 (disregarded, off)	2 (disregarded, off)
	Rx. Pedal	3 (disregarded, omni)	3 (disregarded, off)
	External Zone	On	Off
Comments		Use this template to play on this keyboard and the Pedal-board connected to the MIDI IN jack and control the MIDI equipment connected to the MIDI OUT jack with the External Zone.	Use this template to use MIDI IN jack for play only the Extra Voices with external MIDI keyboard.

MIDI Implementation

Channel Voice Message

Note Off

Status	2nd Byte	3rd Byte
8nH	kkH	vvH, or
9nH	kkH	00H
n=MIDI Channel Number:	0H - FH (Ch. 1 - 16)	
kk=Note Number:	00H - 7FH (0 - 127)	
vv=Velocity(disregard):	00H - 7FH (0 - 127)	

Note On

Status	2nd Byte	3rd Byte
9nH	kkH	vvH
n=MIDI Channel Number:	0H - FH (Ch. 1 - 16)	
kk=Note Number:	00H - 7FH (0 - 127)	
vv=Velocity:	00H - 7FH (0 - 127)	

Control Change

The value set by the Control Change is not reset even when Program Change messages etc. are received.

Bank Select (CC#0, 20)

Status	2nd Byte	3rd Byte
BnH	00H	mmH
BnH	20H	llH
n=MIDI Channel Number:	0H - FH (Ch. 1 - 16)	
mm,ll=Bank Number:	00 00H=User 01 00H=Preset	

Until you send the Program Change, the Bank Select process is reserved.

Expression (CC#11)

Status	2nd Byte	3rd Byte
BnH	0BH	vvH
n=MIDI Channel Number:	0H - FH (Ch. 1 - 16)	
vv=Expression:	00H - 7FH (0 - 127)	

Spring Shock (CC#48)

Status	2nd Byte	3rd Byte
BnH	30H	vvH
n=MIDI Channel Number:	0H - FH (Ch. 1 - 16)	
vv=Velocity:	00H - 7FH (0 - 127)	

Glide (CC#49)

Status	2nd Byte	3rd Byte
BnH	31H	vvH
n=MIDI Channel Number:	0H - FH (Ch. 1 - 16)	
vv=Control Value:	00H - 7FH (0 - 127) 0 - 63=Off, 64 - 127=On	

Damper (CC#64)

Status	2nd Byte	3rd Byte
BnH	40H	vvH
n=MIDI Channel Number:	0H - FH (Ch. 1 - 16)	
vv=Control Value:	00H - 7FH (0 - 127) 0 - 63=Off, 64 - 127=On	

Leslie Fast (CC#92)

Status	2nd Byte	3rd Byte
BnH	5CH	vvH
n=MIDI Channel Number:	0H - FH (Ch. 1 - 16)	
vv=Control Value:	00H - 7FH (0 - 127) 0 - 63=Off, 64 - 127=On	

This control change is only for receive.

NRPN MSB/LSB (CC#98, 99)

Status	2nd Byte	3rd Byte
BnH	63H	mmH
BnH	62H	llH
n=MIDI Channel Number:	0H - FH (Ch. 1 - 16)	
mm=upper byte of the parameter number specified by NRPN		
ll=lower byte of the parameter number specified by NRPN		

Data Entry (CC#6, 38)

Status	2nd Byte	3rd Byte
BnH	06H	mmH
BnH	26H	llH
n=MIDI Channel Number:	0H - FH (Ch. 1 - 16)	
mm,ll=the value of the parameter specified by NRPN		

Program Change

Status	2nd Byte
CnH	ppH
n=MIDI Channel Number:	0H - FH (Ch. 1 - 16)
pp=Program Number:	00H - 63H, 7FH (Patch #1 - 100, Manual)

Example of Patch operation

ex: select Patch U016
Bx 00 00 20 00 Cx 0F (x=Upper Channel)
ex: select Patch P100
Bx 00 01 20 00 Cx 63 (x=Upper Channel)
ex: select [Manual]
Bx 00 00 20 00 Cx 7F (x=Upper Channel)

Channel Mode Message

All Sounds Off (CC#120)

Status	2nd Byte	3rd Byte
BnH	78H	00H
n=MIDI Channel Number:	0H - FH (Ch. 1 - 16)	
<i>When this message is received, all currently-sounding notes on the corresponding channel will be turned off immediately.</i>		

Reset All Controllers (CC#121)

Status	2nd Byte	3rd Byte
BnH	79H	00H
n=MIDI Channel Number:	0H - FH (Ch. 1 - 16)	
<i>When this message is received, the following controllers will be set to their reset values.</i>		
Expression:	127	
Glide:	0	
Damper:	0	
NRPN:	unset; previously set data will not change	

All Sounds Off (CC#123)

Status	2nd Byte	3rd Byte
BnH	7BH	00H
n=MIDI Channel Number:	0H - FH (Ch. 1 - 16)	
<i>When All Notes Off is received, all notes on the corresponding channel will be turned off. However if Hold 1 or Sostenuo is ON, the sound will be continued until these are turned off.</i>		

Drawbar Data List 1

Control Number

Upper: 50H(80)

Lower: 51H(81)

Pedal: 52H(82)

Level	Upper / Lower									Pedal	
	16'	5 1/3'	8'	4'	2 2/3'	2'	1 3/5'	1 1/3'	1'	16'	8'
0	00H(0)	09H(9)	12H(18)	1BH(27)	24H(36)	2DH(45)	36H(54)	3FH(63)	48H(72)	00H(0)	09H(9)
1	01H(1)	0AH(10)	13H(19)	1CH(28)	25H(37)	2EH(46)	37H(55)	40H(64)	49H(73)	01H(1)	0AH(10)
2	02H(2)	0BH(11)	14H(20)	1DH(29)	26H(38)	2FH(47)	38H(56)	41H(65)	4AH(74)	02H(2)	0BH(11)
3	03H(3)	0CH(12)	15H(21)	1EH(30)	27H(39)	30H(48)	39H(57)	42H(66)	4BH(75)	03H(3)	0CH(12)
4	04H(4)	0DH(13)	16H(22)	1FH(31)	28H(40)	31H(49)	3AH(58)	43H(67)	4CH(76)	04H(4)	0DH(13)
5	05H(5)	0EH(14)	17H(23)	20H(32)	29H(41)	32H(50)	3BH(59)	44H(68)	4DH(77)	05H(5)	0EH(14)
6	06H(6)	0FH(15)	18H(24)	21H(33)	2AH(42)	33H(51)	3CH(60)	45H(69)	4EH(78)	06H(6)	0FH(15)
7	07H(7)	10H(16)	19H(25)	22H(34)	2BH(43)	34H(52)	3DH(61)	46H(70)	4FH(79)	07H(7)	10H(16)
8	08H(8)	11H(17)	1AH(26)	23H(35)	2CH(44)	35H(53)	3EH(62)	47H(71)	50H(80)	08H(8)	11H(17)

ex: Set Lower 8' to level 7 via MIDI... Bx 51 19 (x=Lower Channel)

Drawbar Data List 2

Part	Control Number								
	16'	5 1/3'	8'	4'	2 2/3'	2'	1 3/5'	1 1/3'	1'
Upper	0CH(12)	0DH(13)	0EH(14)	0FH(15)	10H(16)	11H(17)	12H(18)	13H(19)	14H(20)
Lower	15H(21)	16H(22)	17H(23)	18H(24)	19H(25)	1AH(26)	1BH(27)	1CH(28)	1DH(29)
Pedal	21H(33)	-	23H(35)	-	-	-	-	-	-

Value	Level								
	0	1	2	3	4	5	6	7	8
00 - 0FH (0 - 15)	10 - 1FH (16 - 31)	20 - 2FH (32 - 47)	30 - 3FH (48 - 63)	40 - 4FH (64 - 79)	50 - 5FH (80 - 95)	60 - 6FH (96 - 111)	70 - 7EH (112-126)	7FH (127)	

ex: Set Lower 8' to level 7 via MIDI... Bx 17 70 (x=Upper Channel)

System Exclusive Message

◆ Memory Dump

1. Each Packet

F0	System Exclusive
55	SUZUKI ID
dd	Device ID (refer to P. 114 #8)
10	Model ID MSB
1F	Model ID LSB
11	Command: Data Packet
[TYPE]	Data Type 02H = All Data Dump 07H = Combi. Temp. Dump 09H = Global Dump 0AH = System Dump
[PNH]	Packet Number MSB
[PNL]	Packet Number LSB
[DATA]	128 Bytes Data 256 Bytes nibblized ASCII ex: 7EH = 37H, 45H
[CHD]	Check Digit Lower 7 bits of XOR [DATA]
F7	End Of Exclusive

2. Acknowledge

F0	System Exclusive
55	SUZUKI ID
dd	Device ID
10	Model ID MSB
1F	Model ID LSB
14	Command: Acknowledge
[TYPE]	Data Type
[AK]	Result 00H = OK 05H = Check Digit Error 06H = Receive Protected
[PNH]	Packet Number MSB
[PNL]	Packet Number LSB
F7	End Of Exclusive

3. # of Packets

All Data Dump:	466
Combi. Temp Dump:	27
Global Dump:	6
System Dump:	1

◆ Dump Request (Rx. only)

F0	System Exclusive
55	SUZUKI ID
dd	Device ID
10	Model ID MSB
1F	Model ID LSB
12	Command: Dump Request
[TYPE]	Data Type 02H = All Data Dump 07H = Combi. Temp. Dump 09H = Global Dump 0AH = System Dump
F7	End Of Exclusive

Mode Setting Exclusive Message

Full Parameters Reset (Rx. only)

F0	System Exclusive
55	SUZUKI ID
dd	Device ID
42	Mode ID for DT1
12	Command: DT1
40	Address MSB
00	Address
7F	Address LSB
7F	Reset
42	Check Sum
F7	End Of Exclusive

NRPN Switch

F0	Suzuki Exclusive
55	SUZUKI ID
dd	Device ID
10	Model ID MSB
1F	Model ID LSB
02	Command: NRPN Sw.
[DATA]	00H = Off, 7FH = On
F7	End Of Exclusive

When this device receives this message, switch Tx & Rx NRPN in Control channel.

Data Set (Rx. only)

F0	System Exclusive
55	SUZUKI ID
dd	Device ID
10	Model ID MSB
1F	Model ID LSB
13	Command: Data Set
aa	Address MSB
bb	Address
cc	Address LSB
[DATA]	Data (Flexible bytes)
F7	End Of Exclusive

Identity Request (Rx. only)

F0	System Exclusive
7E	Universal non real-time
dd	Device ID
06	Sub ID #1
01	Sub ID #2
F7	End Of Exclusive

Identity Reply (Tx. only)

F0	System Exclusive
7E	Universal non real-time
dd	Device ID
06	Sub ID #1
02	Sub ID #2
55	SUZUKI ID
00 10	Device Family code
00 1F	Device Family number
00 00	
00 00	
F7	End Of Exclusive

When Identity Request is received, Identity Reply will be transmitted.

Global Parameters

Category	Parameter	NRPN		SysEx Address			SysEx Length	Data	Default	Description
		LSB (62)	MSB (63)	MSB to LSB						
Tune	Transpose	01	00	00	01	00	01	3A - 40 - 46 (-6 - 0 - 6)	40	0
	Master Tune	01	02	00	01	02	02	032E - 0338 - 0342 (430 - 440 - 450)	0338	440
Expression	Source	02	00	00	02	00	01	00 - 01 00: Pedal (normal) 01: Pedal (reverse) 02: MIDI	00	Pedal (normal)
	Min. Level	02	08	00	02	08	01	00 - 09 (Off, -40dB - 0dB)	06	-35dB
	Min. Limit LF	02	09	00	02	09	01	00 - 08	05	-20dB
	Min. Limit HF	02	0A	00	02	0A	01	(Off, -40dB - -5dB)	03	-30dB
Foot Switch	FS Device	03	00	00	03	00	01	00 - 01 (Foot Sw., Leslie Sw.)	00	Foot Sw.
	FS Tip Mode	03	01	00	03	01	01	00 - 25 00: Off 01: Leslie Fast (alternate) 02: Leslie Fast (momentarily) 03: Leslie Fast (tri-state) 04: Glide 05: Patch Fwd. 06: Patch Back 07: Favorite Fwd. 08: Favorite Back 09: Spring Shock 0A: Delay Time 0B: Music Start 0C: Manual Bass 0D - 25: Bass 1C - 3C	01	Leslie Fast (alternate)
	FS Ring Mode	03	02	00	03	02	01	same as FS Tip mode	01	Leslie Fast (alternate)
	Damper Org. Upper	03	03	00	03	03	01	00, 01 (Off/On)	01	On
	Damper Org. Lower	03	04	00	03	04	01	00, 01 (Off/On)	01	On
	Damper Org. Pedal	03	05	00	03	05	01	00, 01 (Off/On)	01	On
	Damper Extra Voice	03	06	00	03	06	01	00, 01 (Off/On)	01	On
	Octave Down Mode	03	07	00	03	07	01	00 - 07 00: Origin 01: Leslie Stop 02: Leslie Fast 03: Vibrato Upper 04: Vibrato Lower 05: Glide 06: Spring Shock 07: Delay Time	00	Origin
Panel Switch	Octave Up Mode	03	08	00	03	08	01	same as above	00	Origin
	Octave Lower Mode	03	09	00	03	09	01	same as above	00	Origin
Patch Load	Drawbar Regist. Upper	60	00	00	60	00	01	00, 01 (Off/On)	01	On
	Drawbar Regist. L/P	60	01	00	60	01	01	00, 01 (Off/On)	01	On
	Drawbar Parameters (DRAWB)	60	02	00	60	02	01	00, 01 (Off/On)	01	On
	Extra Voice (EXV)	60	03	00	60	03	01	00, 01 (Off/On)	01	On
	Internal Zone (INT)	60	04	00	60	04	01	00, 01 (Off/On)	01	On
	External Zone (EXT)	60	05	00	60	05	01	00, 01 (Off/On)	01	On
	Organ Effect (DRAWB)	60	06	00	60	06	01	00, 01 (Off/On)	01	On
	Extra Voice Effect (EXV)	60	07	00	60	07	01	00, 01 (Off/On)	01	On
	Reverb (REV)	60	08	00	60	08	01	00, 01 (Off/On)	01	On
	Animation (ANI)	60	09	00	60	09	01	00, 01 (Off/On)	01	On
Favorites	Overwrite Patch	04	00	00	04	00	01	00, 01 (Off/On)	00	Off
Display	Short Cut	--	--	--	--	--	--	0, 1, 2s, No		
	Time Out	--	--	--	--	--	--	4, 8, 16s, No		
	Pop Up	--	--	--	--	--	--	No, 0.5, 1, 2s		
Master EQ	Bass Freq.	02	0F	00	02	0F	01	00 - 0A (20 - 200Hz)	07	100Hz
	Treble Freq.	02	10	00	02	10	01	00 - 03 (4.0k - 8.0kHz)	03	8.0kHz

Example Set Transpose at 0 via NRPNBx 62 01 63 00 06 40 (x = Upper channel)
 Set Transpose at 0 via System Exclusive.....F0 55 dd 10 1D 13 00 01 00 40 F7 (dd = Device ID)

Patch Parameters

Category	Parameter	NRPN		SysEx Address			SysEx Length	Data	Patch Load
		LSB (62)	MSB (63)	MSB to LSB					
Name	15 Characters	--	--	01	00	00	0F	7 bit ASCII	always
Internal Zone	Manual Bass	07	00	00	07	00	01	00, 01 (Off/On)	INT
	Manual Bass Mode	07	01	00	07	01	01	00 - 02 (Lower, Chord, Poly)	
	Manual Bass Range Hi	07	02	00	07	02	01	24 - 60 (MIDI note number)	
	Great To Pedal	07	03	00	07	03	01	00, 01 (Off/On)	
	G to P Range Hi	07	04	00	07	04	01	24 - 3C (MIDI note number)	
	Split	07	05	00	07	05	01	00, 01 (Off/On)	
	Split Point	07	06	00	07	06	01	24 - 60 (MIDI note number)	
	Key Octave Upper 1	07	07	00	07	07	01	3E - 40 - 42 (-2 - 0 - +2)	
	Key Octave Lower 1	07	08	00	07	08	01	3E - 40 - 42 (-2 - 0 - +2)	
	Glide Length	07	09	00	07	09	01	00 - 18 (0 - 24 semitones)	
	Glide Time	07	0A	00	07	0A	01	00 - 31 (0.1 - 5.0 seconds)	
	Glide Amp	07	0B	00	07	0B	01	00, 01 (Off/On)	
	Key Octave Upper 2	07	0C	00	07	0C	01	3E - 40 - 42 (-2 - 0 - +2)	
Key Octave Lower 2	07	0D	00	07	0D	01	3E - 40 - 42 (-2 - 0 - +2)		
External Zone	MIDI Channel	4n	00	00	4n	00	01	00 - 0F (1 - 16)	EXT
	Switch	4n	01	00	4n	01	01	00, 01 (Off/On)	
	Allocate	4n	02	00	4n	02	01	00 - 03 00: Off 01: Upper 02: Lower 03: Pedal	
	Key Range Lo	4n	03	00	4n	03	01	24 - 60 (MIDI note number)	
	Key Range Hi	4n	04	00	4n	04	01	24 - 60 (MIDI note number)	
	Bank Select MSB	4n	05	00	4n	05	01	00 - 7F	
	Bank Select LSB	4n	06	00	4n	06	01	00 - 7F	
	Program Change	4n	07	00	4n	07	01	00 - 7F	
	Octave Shift	4n	08	00	4n	08	01	3E - 40 - 42 (-2 - 0 - +2)	
	Volume	4n	09	00	4n	09	01	00 - 7F	
	Pan	4n	0A	00	4n	0A	01	00 - 40 - 7F (L64 - C - R63)	
	Velocity	4n	0B	00	4n	0B	01	00 - 04 (Off, Normal - Easy)	
	Expression Minimum	4n	0C	00	4n	0C	01	00 - 3F (0 - 63)	
	Expression Maximum	4n	0D	00	4n	0D	01	40 - 7F (64 - 127)	
	Expression CC#	4n	0E	00	4n	0E	01	00, 01 (7, 11)	
Tx. Damper On	4n	0F	00	4n	0F	01	00, 01 (Off/On)		
Extra Voice	Switch Upper	50	00	00	50	00	01	00, 01 (Off/On)	EXV
	Switch Lower	50	01	00	50	01	01	00, 01 (Off/On)	
	Switch Solo	50	02	00	50	02	01	00, 01 (Off/On)	
	Octerve Shift	50	03	00	50	03	01	3E - 40 - 42 (-2 - 0 - +2)	
	Key Range Lo	50	04	00	50	04	01	24 - 60 (MIDI note number)	
	Key Range Hi	50	05	00	50	05	01	24 - 60 (MIDI note number)	
	Inst. Group	50	06	00	50	06	01	00 - 06 (1 - 7)	
	Inst. Number	50	07	00	50	07	01	00 - 7F (1 - 128)	
	Volume	50	08	00	50	08	01	00 - 7F (0 - 127)	
	Velocity	50	09	00	50	09	01	00 - 04 (Off, Normal - Easy)	
Expression	50	0A	00	50	0A	01	00, 01 (Off/On)		

Example "n" means Zone number. 1=0, 2=1, 3=2
 Turn Extra Voice On via NRPNBx 62 50 63 00 06 01 (x = Upper channel)
 Turn Extra Voice On via System ExclusiveF0 55 dd 10 1F 13 00 50 00 01 F7 (dd = Device ID)

Category	Parameter	NRPN		SysEx Address			SysEx Length	Data	Patch Load
		LSB (62)	MSB (63)	MSB to LSB					
Percussion	Second On	08	00	00	08	00	01	00, 01 (Off/On)	DRAWB
	Third On	08	01	00	08	01	01	00, 01 (Off/On)	
	Decay Fast	08	02	00	08	02	01	00, 01 (Off/On)	
	Volume Soft	08	03	00	08	03	01	00, 01 (Off/On)	
	Level On Soft	08	04	00	08	04	01	00 - 0F (1 - 16)	
	Level On Normal	08	05	00	08	05	01	00 - 0F (1 - 16)	
	Decay Fast	08	06	00	08	06	01	00 - 09 (1 - 9, Cont)	
	Decay Slow	08	07	00	08	07	01	00 - 09 (1 - 9, Cont)	
	Touch	08	08	00	08	08	01	00, 01 (Off/On)	
	Velocity	08	09	00	08	09	01	00, 01 (Off/On)	
	Key Track	08	0A	00	08	0A	01	00, 01 (Off/On)	
	Drawbar 1' Cancel	08	0B	00	08	0B	01	00, 01 (Off/On)	
Drawbar Level	08	0C	00	08	0C	01	00, 01 (0, -3dB)		
Lower & Upper Organ section	Organ Type	20	00	00	20	00	01	00 - 05 00: B-Type 1 01: B-Type 2 02: Mellow 03: Vx 04: Farf 05: Pipe	DRAWB
	Key Click Attack	20	01	00	20	01	01	00 - 0F (0 - 15)	
	Key Click Release	20	02	00	20	02	01	00 - 0F (0 - 15)	
	Fold Back Lo	20	03	00	20	03	01	00 - 0C (C1 - C2)	
	Fold Back Hi	20	04	00	20	04	01	2B - 30 (G4 - C5)	
	Key Click LPF	20	05	00	20	05	01	00 - 7F (0 - 127)	
	Custom TW B-Type 1	20	06	00	20	06	01	00 - 04 (1 - 5)	
	Custom TW B-Type 2	20	07	00	20	07	01	00 - 04 (1 - 5)	
	Custom TW Mellow	20	08	00	20	08	01	00 - 04 (1 - 5)	
	Octerve Shift Upper	20	09	00	20	09	01	3E - 40 - 42 (-2 - 0 - +2)	
	Key Range Lo Upper	20	0A	00	20	0A	01	24 - 60 (MIDI note number)	
	Key Range Hi Upper	20	0B	00	20	0B	01	24 - 60 (MIDI note number)	
	Octerve Shift Lower	20	0C	00	20	0C	01	3E - 40 - 42 (-2 - 0 - +2)	
	Key Range Lo Lower	20	0D	00	20	0D	01	24 - 60 (MIDI note number)	
Key Range Hi Lower	20	0E	00	20	0E	01	24 - 60 (MIDI note number)		
Upper Registration	16'	--	--	01	01	00	01	00 - 08 (0 - 8)	UPPER
	5 1/3'	--	--	01	01	01	01	00 - 08 (0 - 8)	
	8'	--	--	01	01	02	01	00 - 08 (0 - 8)	
	4'	--	--	01	01	03	01	00 - 08 (0 - 8)	
	2 2/3'	--	--	01	01	04	01	00 - 08 (0 - 8)	
	2'	--	--	01	01	05	01	00 - 08 (0 - 8)	
	1 3/5'	--	--	01	01	06	01	00 - 08 (0 - 8)	
	1 1/3'	--	--	01	01	07	01	00 - 08 (0 - 8)	
Lower Registration	16'	--	--	01	02	00	01	00 - 08 (0 - 8)	L/P
	5 1/3'	--	--	01	02	01	01	00 - 08 (0 - 8)	
	8'	--	--	01	02	02	01	00 - 08 (0 - 8)	
	4'	--	--	01	02	03	01	00 - 08 (0 - 8)	
	2 2/3'	--	--	01	02	04	01	00 - 08 (0 - 8)	
	2'	--	--	01	02	05	01	00 - 08 (0 - 8)	
	1 3/5'	--	--	01	02	06	01	00 - 08 (0 - 8)	
	1 1/3'	--	--	01	02	07	01	00 - 08 (0 - 8)	
1'	--	--	01	02	08	01	00 - 08 (0 - 8)		

146 MIDI INFORMATION - continued

Category	Parameter	NRPN		SysEx Address			SysEx Length	Data	Preset Load
		LSB (62)	MSB (63)	MSB to LSB					
Pedal	Tonewheel Set	22	00	00	22	00	01	00 - 03 00: Normal 01: Muted 02: Synth 1 03: Synth 2	DRAWB
	Attack	22	01	00	22	01	01	00 - 04 00: Slow Attack 01: No Click 02: Soft Click 03: Normal Click 04: Max Click	
	Sustain On	22	03	00	22	03	01	00, 01 (Off/On)	
	Sustain Length	22	04	00	22	04	01	00 - 04 (1 - 5)	
	Decay Length	22	05	00	22	05	01	00 - 05 (1 - 5, Cont)	
	Velocity	22	06	00	22	06	01	00 - 04 (Off, Normal - Easy)	
	Key Mode	22	07	00	22	07	01	00, 01 (Mono/Poly)	
	Octerve Shift	22	08	00	22	08	01	3E - 40 - 42 (-2 - 0 - +2)	
	Key Range Lo	22	09	00	22	09	01	24 - 60 (MIDI note number)	
Key Range Hi	22	0A	00	22	0A	01	24 - 60 (MIDI note number)		
Pedal Registration	16'	--	--	01	03	00	01	00 - 08 (0 - 8)	L/P
	8'	--	--	01	03	01	01	00 - 08 (0 - 8)	
Organ Effect	Leslie Bypass	09	00	00	09	00	01	00, 01 (Enable / Bypass)	ANI
	Leslie Fast	09	01	00	09	01	01	00, 01 (Slow / Fast)	
	Leslie Stop	09	07	00	09	07	01	00, 01 (Turn / Stop)	
	Leslie Cabinet Number	09	08	00	09	08	01	00 - 07 (1 - 8)	
	Vibrato On Swell	09	04	00	09	02	01	00, 01 (Off/On)	
	Vibrato On Great	09	03	00	09	03	01	00, 01 (Off/On)	
	Vibrato Mode	09	04	00	09	04	01	00 - 05 (V1 - C3)	
	Vibrato Rate	09	05	00	09	05	01	00 - 04 (6.1 - 7.25Hz)	
	Vibrato V1 Depth	09	0D	00	09	0D	01	00 - 0F (1 - 16)	
	Vibrato V2 Depth	09	0E	00	09	0E	01	00 - 0F (1 - 16)	
	Vibrato V3 Depth	09	0F	00	09	0F	01	00 - 0F (1 - 16)	
	Vibrato C1 Depth	09	10	00	09	10	01	00 - 0F (1 - 16)	
	Vibrato C2 Depth	09	11	00	09	11	01	00 - 0F (1 - 16)	
	Vibrato C3 Depth	09	12	00	09	12	01	00 - 0F (1 - 16)	
	Vibrato Tremolo	09	13	00	09	13	01	00 - 0F (0 - 15)	
	Vibrato Cho. Emphasis	09	14	00	09	14	01	00 - 09 (0 - 9)	
Vibrato On Pedal	09	15	00	09	15	01	00, 01 (Off/On)		

Category	Parameter	NRPN		SysEx Address			SysEx Length	Data	Preset Load
		LSB (62)	MSB (63)	MSB	to	LSB			
Effects	Overdrive On	3p	00	00	3p	00	01	00, 01 (Off/On)	EFFECT p=0: DRAWB p=1: EXV
	Overdrive Type	3p	01	00	3p	01	01	00 - 03 00: Tube 01: Stomp Box 02: Clip 03: E. Pf. Amp	
	Overdrive Drive Level	3p	02	00	3p	02	01	00 - 7F	
	Overdrive Controlled Exp.	3p	03	00	3p	03	01	00-03 00: EX-OD 01: OD-EX 02: OD Only 03: Input	
	Multi Effect On	3p	04	00	3p	04	01	00, 01 (Off/On)	
	Multi Effect Type	3p	05	00	3p	05	01	00-07 00: Tremolo 01: Auto Pan 02: Wah-Wah 03: Ring Mod. 04: Phaser 05: Flanger 06: Chorus 07: Delay	
	Multi Effect Parameter 0	3p	06	00	3p	06	01	00-03	
	Multi Effect Parameter 1	3p	07	00	3p	07	01	00-03	
	Multi Effect Parameter 2	3p	08	00	3p	08	01	00-7F	
	Multi Effect Parameter 3	3p	09	00	3p	09	01	00-7F	
	Multi Effect Parameter 4	3p	0A	00	3p	0A	01	00-7F	
	Multi Effect Parameter 5	3p	0B	00	3p	0B	01	00-7F	
	Multi Effect Parameter 6	3p	0C	00	3p	0C	01	00-7F	
	Multi Effect Parameter 7	3p	0D	00	3p	0D	01	00-7F	
	EQ Bass Gain	3p	0E	00	3p	0E	01	00 - 09 - 12 (-9 - 0 - +9)	
	EQ Bass Frequency	3p	0F	00	3p	0F	01	00 - 0A (20 - 200Hz)	
	EQ Mid Gain	3p	10	00	3p	10	01	00 - 09 - 12 (-9 - 0 - +9)	
	EQ Mid Frequency	3p	11	00	3p	11	01	00 - 0A (250 - 3.1kHz)	
	EQ Treble Gain	3p	12	00	3p	12	01	00 - 09 - 12 (-9 - 0 - +9)	
	EQ Treble Frequency	3p	13	00	3p	13	01	00 - 03 (4.0 - 8.0 kHz)	
	EQ Tone Control	3p	14	00	3p	14	01	00 - 09 - 12 (-9 - 0 - +9)	
	Reverb On	0A	00	00	0A	00	01	00, 01 (Off/On)	REV
	Reverb Type	0A	01	00	0A	01	01	00 - 0A 00: Room 1 01: Room 2 02: Live House 03: Hall 1 04: Hall 2 05: Church 06: Plate 07: Spring 08: Delay 09: Panning Delay 0A: Reverb + Delay	
	Reverb Level	0A	02	00	0A	02	01	00 - 7F (0 - 127)	
	Reverb Time	0A	03	00	0A	03	01	00 - 7F (0 - 127)	
	Reverb Delay Feedback	0A	04	00	0A	04	01	00 - 1F (0 - 96%)	
	Reverb Delay Time	0A	05	00	0A	05	01	00 - 44 (4.7 - 2000ms)	

Example: "p" means Section number. Organ=0, Extra Voice=1
 Set Multi-Effect EXV at Phaser via NRPNBx 63 05 62 31 06 04 26 00 (x = Upper channel)
 Set Multi-Effect EXV at Phaser via SysExF0 55 dd 10 1F 13 00 31 05 04 F7 (dd = Device ID)

Leslie Parameters

Category	Parameter	NRPN (OR)		NRPN (21)		SysEx Address			SysEx Length	Data
		LSB (62)	MSB (63)	LSB (62)	MSB (63)	MSB to LSB				
Cabinet	Name	--	--	--	--	03	00	00	0A	(10 Characters)
	Slow Speed Horn	06	00	7F	00	00	06	00	01	
	Slow Speed Bass	06	01	7F	01	00	06	01	01	
	Fast Speed Horn	06	02	7F	02	00	06	02	01	
	Fast Speed Bass	06	03	7F	03	00	06	03	01	
	Rise Time Horn	06	04	7F	04	00	06	04	01	
	Rise Time Bass	06	05	7F	05	00	06	05	01	
	Fall Time Horn	06	06	7F	06	00	06	06	01	
	Fall Time Bass	06	07	7F	07	00	06	07	01	
	Brake Time Horn	06	08	7F	08	00	06	08	01	
	Brake Time Bass	06	09	7F	09	00	06	09	01	
	Level Horn	06	0A	--	--	00	06	0A	01	
	Level Bass	06	0B	--	--	00	06	0B	01	
	Mic. Angle	06	0C	7F	0A	00	06	0C	01	
	Mic. Distance	06	0D	7F	0B	00	06	0D	01	
	Horn Character	06	0E	7F	0D	00	06	0E	01	
	Amplifier	06	0F	--	--	00	06	0F	01	
Speaker	06	10	--	--	00	06	10	01		

NRPN OR/21 is switched automatically by Leslie speaker is disconnected/connected.

System Parameters

Category	Parameter	Data Range	Default Value
MIDI	MIDI IN	Lower, Pedal, Low+Ped, Sequence, ExVoice, Upper, Upp+Ped	Sequence
	Local Control	Off/On	On
	TRx. NRPN	Off/On	On
	Tx. Leslie Param.	OR/21	SK
	Rx. Dump	Off/On	On
	TRx. Prog. Change	Off/On	On
	TRx. Drawbar Regi.	Off/On	On
	Tx. Ext. Zone	Off/On	Off
	TRx. Channel Upper	1 - 16, Off	1
	TRx. Channel Lower	1 - 16, Off	2
	TRx. Channel Pedal	1 - 16, Off	3
	Device ID	1 - 32	1
Music Player	Chain	All, One, Shuffle	All
Keyboard	Velocity Offset	-32 - +32	0
	Sounding Point	Deep / Auto	Deep
Audio	Output	Stereo / Mono	Stereo
Ext. Leslie	Channel(s)	1, 3	3

Tonewheel Parameters

Category	Parameter	Data Range
Tone-Wheels	Name	(10 characters)
	Level	-20 - +2 [dB]
	HPF Cut Off Freq.	0 - 127
	LPF Cut Off Freq.	0 - 127
	LPF Resonance	-100 - +100

Pipe Parameters

Category	Parameter	Data Range
Pipe	Volume	0 - 127
	Detune	-50 - +50
	Chiff	Off, Soft, Mid, Loud
	Cut Off Freq.	-64 - +0
	Pan - Direction	L64 - C - R63
	Pan - Imaging	Fixed, L-R, R-L, Pyramid, Inverted Pyramid

◆ BType1, BType2

Real B-3

Type based upon a B-3 in good condition. It contains moderate motor hum and leakage noise.

80's Clean

Type based upon the popular clear sound 80's B-3. The motor hum or leakage noise has been removed, the delicate "vibration" caused by the wow-flutter of the motor still remains.

Noisy

This is a custom replicating the entire sound output from the B-3, including the motor hum and leakage noise.

Noisy 60

Type based upon very prominent leakage noise.

◆ Mellow

Full Flats

Type based on perfect sine waves, and a hypothetical Hammond in which all tone wheels oscillate at the same volume.

Husky

Type with characteristics of mid-range and reduced volume.

Flute Lead

Type with characteristics of reduced bass and treble, opposite to the "Husky".

Cheap Tr.s

Like a portable radio, reduced bass-range.

MIDI IMPLEMENTATION CHART

Stage Keyboard
Model: SK1, SK2

MIDI Implementation Chart

Date: 28-Sep-2012
Version: 1.4

Function		Transmitted	Recognized	Remarks
Basic Channel	Default Changed	*1 1 - 16	*1 1 - 16	*1: Upper = 1, Lower = 2, Pedal = 3
Mode	Default Messages Altered	3 X *****	3 X X	
Note Number	: True Voice	12 - 120 *****	36 - 96 36 - 96	
Velocity	Note ON Note OFF	O X	O X	
After Touch	Key's Ch's	X X	X X	
Pitch Bend		X	X	
Control Change	0, 32	O	O	Bank Select MSB, LSB
	1	X	X	Modulation
	6, 38	O	O	Data Entry MSB, LSB
	7	O	X	Volume
	10	O	X	Pan
	11	O	O	Expression
	12 - 20, 80	O	O	Drawbar Reg. Upper
	21 - 29, 81	O	O	Drawbar Reg. Lower
	33, 35, 82	O	O	Drawbar Reg. Pedal
	48	O	O	Spring Shock
	49	O	O	Glide
	64	O	O	Damper
	92	X	O	Leslie Fast
98, 99	O	O	NRPN MSB, LSB	
Program Change	: True #	O 0 - 127	O 0 - 81	
System Exclusive		O	O	
System Common	: Song Position : Song Select : Tune	X X X	X X X	
System Real Time	: Clock : Commands	X X	X X	
Aux Messages	: All Sounds Off : Reset All Controllers : Local On/Off : All Notes Off : Active Sense : Reset	X O X O O X	O O X O O X	(120) (121)

Mode 1: OMNI ON, POLY Mode 2: OMNI ON, MONO
Mode 3: OMNI OFF, POLY Mode 4: OMNI OFF, MONO

O: Yes
X: No

MIDI CHANNELS AND MESSAGES

	External Zone (Tx. only)	Upper Part	Lower Part	Pedal Part
Note	O	O	O	O
Pitch Bend	X	X	X	X
Modulation	X	X	X	X
Volume, Pan (7, 10)	O	X	X	X
Expression (11)	O	O *2	X	X
Hold 1 (64)	O	O	O	O
Drawbar Reg.	X	CC#80, 12 - 20 (Upper) 21 - 29 (Lower) 33, 35 (Pedal)	CC#81	CC#82
Spring Shock (48)	X	O	X	X
RPN (100, 101)	X	X	X	X
NRPN (98, 99)	X	O	X	X
All Notes Off (123)	O	O	O	O
All Sounds Off (120)	X	O *3	O *3	O *3
Reset All Ctrl. (121)	O	O	O	O
After Touch	X	X	X	X
Bank Select (0, 32)	Change the voice for each zone.	Patch	X	X
Program Change			X	X

*1: It works for both Swell, Great and Pedal.

*2: It works for all parts (audio controlled)

*3: For Rx. only.

Sound Generator

Organ Section

- 2 - VASE III as Digital Tone-wheels, Transistor Organ and Pipe Organ
- 61 polyphony (for manual, except Pipe Organ)
- 8 polyphony (for pedal, except Pipe Organ)
- 63 polyphony (maximum, on Pipe Organ)

Extra Voice Section

- VASE III, 63 polyphony (maximum)

Keyboards

- C1 to C6 61-key (SK1)
- F0 to F6 73-key (SK1-73)
- A-1 to C7 88-key semi-weighted (SK1-88)
- 2 x C1 to C6 61-key (SK2)

Harmonic Drawbars

Drawbars

- 9 Pitches, assignable for Upper, Pedal, Lower

Voicing

- Manuals: 6 choices (B-Type1, B-Type2, Mellow, Vx, Farf, Pipe), variable key-click
- Pedal: 4 choices (Normal, Muted, Synth1, Synth2), 5 choices key-click

Touch Response Percussion

Buttons

- Second Harmonic, Third Harmonic, Fast Decay, Volume Soft

Adjustable

- Touch, Velocity, Decay (Fast, Slow), Level (Normal, Soft)

Extra Voice

Instruments

- 6 Groups (A. Piano, E. Piano, Keyboard, Wind, Other, Library)
- Upgradable via Library

Control

- Allocate Upper/Lower, Solo, Group

Effects

Vibrato and Chorus

- Digital Scanner
- Buttons: 1, 2, Chorus, Upper On, Lower On

Overdrive

- Digital, 4 programs
- Control: On, Amount

Multi Effects

- 8 programs for Organ/Extra Voice individually
- Control: On, Amount

Equalizer

- for Organ: Bass, Mid (sweep), Treble, Tone
- for Extra Voice: Bass, Mid (sweep), Treble

Internal Leslie

- Advanced Digital, 2 Rotors
- Buttons: Bypass, Stop, Fast

Reverb

- Digital, 11 programs
- Control: On, Depth

Master Equalizer

- Control: Bass, Mid Gain, Mid Frequency, Treble

Keymap

Buttons

- Manual Bass, Split (SK1 only), Lower to Pedal (SK2 only) Octave Up, Octave Down, Lower, Transpose

Adjustable

- Coupler Highest note, Split Point

Patches

Capacity

- 100 User Patches, 100 Preset Patches, Manual

Favorites

- 10 buttons

Patch Load Options

- Drawbar Registration, Drawbar Parameters, Extra Voice, Internal Zone, External Zone, Organ Effects, EXV Effects, Reverb

Controllers

Volumes

- Master Volume, Music Volume, Extra Voice Volume

Switch

- Power On/Off

Music Player

File Format

- WAV (44.1kHz, 16bit, Stereo), MP3 (44.1kHz, 128kbps, Stereo)

Control

- Song, Play/Pause

Storage

- USB Flash Drive

Display

- 20 - Characters, 2 - Lines
- 8 Control Buttons and Value knob

MIDI

Templates

- 9 Templates(SK1), 5 Templates(SK2)

External Zones

- 3 Zones, assignable any keyboards

Connections

MIDI

- In, Out

Audio

- Line Out L, R, Headphones

Leslie

- 8 - pin, 1 and 3 channels available

Other

- Foot Switch, Damper Pedal, Exp. Pedal, DC IN (12V)

Accessory

- AC Adaptor AD3-1250

Dimensions

- SK1: 894(W), 303(D), 99(H) mm
- SK1-73: 1124(W), 303(D), 99(H) mm
- SK1-88: 1316(W), 314(D), 99(H) mm
- SK2: 944(W), 454(D), 170(H) mm

Weight

- SK1: 7kg
- SK1-73: 9.3kg
- SK1-88: 11.6kg
- SK2: 16kg

PRESET PATCH LIST

Category	#	Name
High Lights	P001	The Rock!
	P002	Jazz Tune
	P003	Testify!
	P004	Glory Pipes
	P005	Light'n Up
	P006	Absolutely Richard
	P007	Respect Piano
	P008	Groovy Donny
	P009	Trust Clav.
	P010	Splitted Brass Prochord
Rock / Pop	P011	Purple
	P012	The Gnome
	P013	Some Lovin
	P014	White Shade
	P015	Soloist
	P016	Ring Heaven
	P017	Light Fire
	P018	Neon Shuf
	P019	Don't Run
	P020	Lucy's Sky
A / E Piano	P021	Stereo Grand Piano
	P022	Bright Grand Piano
	P023	Mono Grand Piano
	P024	Saturday Park
	P025	Panning E. Piano
	P026	Phasing E. Piano
	P027	Chorus E. Piano
	P028	Galaxy FM
	P029	Ballad Wurly
	P030	Rock Wurly
Keyboard	P031	Super Wonder
	P032	Rock Nuts
	P033	Wah Clav.
	P034	Flanged Clav.
	P035	Macarena Clav.
	P036	Harpsichord
	P037	Coupled Harpsichord
	P038	Accordion MMM
	P039	Enka Lead
	P040	Tornado
Wind	P041	Prochorded Flute Sect.
	P042	Prochorded Big Band
	P043	Prochorded Sax Sect.
	P044	Prochorded Brass Sect.
	P045	Prochorded Mute Combo
	P046	Solo Flute
	P047	Solo Alto Sax
	P048	Solo Trumpet
	P049	Trumpet + Trombone
	P050	Muted Tp + Tb

Category	#	Name
Jazz Organ	P051	Hey! Jimmy
	P052	Crazy! Baby
	P053	Mack The Knife
	P054	The Lower Manual
	P055	Full Swing
	P056	Mighty Burner
	P057	Groove Richard
	P058	Five Spot
	P059	Sweet Ballad
	P060	Walter's Summer
Gospel Organ	P061	Classic Gospel
	P062	Slow Gospel
	P063	Contemp. Gospel
	P064	Shout Gospel
	P065	Quiet Praise
	P066	Reflective Praise
	P067	Dramatic Praise
	P068	Total Praise
	P069	Meditation
	P070	Full Gospel
Pipe Organ	P071	Pianissimo
	P072	Piano
	P073	Mezzo Piano
	P074	Mezzo Forte
	P075	Forte
	P076	Fortissimo
	P077	Reed Solo
	P078	Sforzando
	P079	Split Positiv Org / Piano
	P080	Split Positiv Org / Strings
Others	P081	Theater Glock Org
	P082	Jazz Vibes + Organ
	P083	Electro Strings
	P084	SX/CX Strings
	P085	Fake Arpeggio
	P086	Sleng Teng
	P087	Chameleon
	P088	Slice Pad
	P089	Pcd Duo Lead
	P090	1960's Sci-Fi
Appendix	P091	TW Organ / E. Pf
	P092	Brass / Tonewheel
	P093	Tonewheel / Funny
	P094	A. Piano Pad
	P095	Breathy T. Sax
	P096	Growl T. Sax
	P097	Drawbars Flute
	P098	Drawbars Reed
	P099	Drawbars Diapason
	P100	Drawbars String

Index

A

- Allocate 58
- Assign 80

B

- Back Up 22

C

- Cabinet Number 84
- Control 78
- Coupler 34, 55
- Custom Tone-Wheels 87, 149

D

- Damper 80
- Default 103
- Display 81
- Drawbar Registration 44
- Drawbars 29, 74
- Drawbars Select 29, 49

E

- Effects 92
- Equalizer 100
- Expand The Keyboard 18
- Expression 77, 79
- Expression Pedal 26
- External Sequencer 110
- External Zone 112
- External Zone Channel 108
- Extra Voice 58, 77, 136

F

- Factory Settings 22
- Farf 47
- Favorites 24, 76
- Folder Structure 118
- Foot Switch 26, 78
- Function Mode 68

G

- Glide 79

H

- Harmonic Drawbars 42

I

- Instrument 31
- Internal Zone 112

K

- Keyboard Channels 108, 115
- Key Click 74
- Key Mode 75

L

- Leakage Noise 88
- Leslie 30, 53, 84
- Leslie Channel 17, 86
- Leslie Parameters 84
- Leslie Speaker 17
- Library 58
- Locking The Display 36
- Lower to Pedal 34

M

- MANUAL 28
- Manual Bass 33, 55
- Master Equalizer 27
- Master Tune 102
- M. BASS. *see*: Manual Bass
- Menu Mode 66
- MIDI 105, 114
- MIDI Keyboards 18
- MIDI Sound Module 111
- MIDI Template 114, 138
- MONO 75, 104
- Multi-Effects 30, 32, 54, 59
- Music Player 125

O

- Octave 56
- Organ Type 40, 74
- Overdrive 30, 52, 92

P

- Panic Function 113
- Parameter 70
- Part 33
- Patch 23, 60, 76
- patch file 123
- Patch Load 60, 76
- Pedalboard 20
- Pedal Sustain 34, 55
- Percussion 29, 50, 82
- Pipe 40, 48, 90
- Play Mode 65
- POLY 75, 112
- Power 22
- Preset 23
- Pro-Chord 58

P. SUS. *see*: Pedal Sustain

R

- Re-Load 113
- Reverb 32, 54, 59, 101

S

- Setup 120, 123
- Setup File 118
- Short Cut 69
- Solo 58
- Sounding Point 81
- Split 33, 56
- Spring Reverb 78
- STEREO 104
- System 104

T

- Tip and Ring 78
- Transpose 57
- Tune 102

U

- USB Flash Drive 118
- User 23

V

- Velocity Offset 81
- Vibrato & Chorus 30, 51, 83
- Voice Group 31
- Voice Library 129
- Vx 40, 46

Z

- Zones 112

Hammond maintains a policy of continuously improving and upgrading its instruments and therefore reserves the right to change specifications without notice. Although every attempt has been made to insure the accuracy of the descriptive contents of this Manual, total accuracy cannot be guaranteed.

Should the owner require further assistance, inquiries should first be made to your Authorized Hammond Dealer.

If you still need further assistance, contact Hammond at the following addresses:

In the United States Contact:

HAMMOND SUZUKI USA, Inc.
743 Annoreno Dr.
Addison, IL 60101
UNITED STATES

E-mail: info@hammondorganco.com
Web site: www.hammondorganco.com

In Europe contact:

HAMMOND SUZUKI EUROPE B. V.
I.R. D. S. Tuynmanweg 4A
4131 PN Vianen
THE NETHERLANDS

E-mail: info@hammond.eu
Web site: www.hammond.eu

All other countries contact:

HAMMOND SUZUKI Ltd.
25-11, Ryoke 2 Chome,
Naka-ku, Hamamatsu
430-0852 (Shizuoka)
JAPAN

E-mail: suzukicorp@suzuki-music.co.jp
Web site: www.suzuki-music.co.jp

Technical materials are available and can be obtained by mailing a request to the appropriate address listed above marked ATTENTION: SERVICE DEPARTMENT.

Manufacturer:
SUZUKI MUSICAL INSTRUMENT MFG. CO., Ltd.
25-12, Ryoke 2 Chome, Naka-ku,
Hamamatsu 430-0852 (Shizuoka)
JAPAN

